











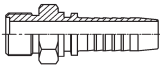

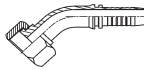
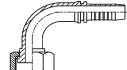
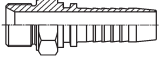
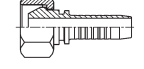

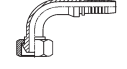



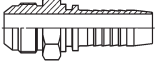
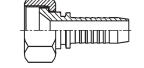
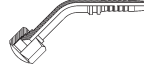
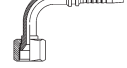

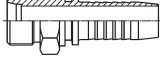
# Fittings

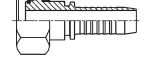

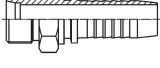
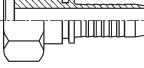
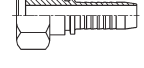

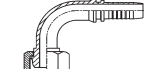
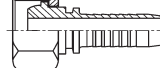

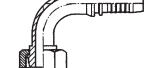
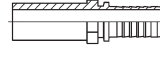

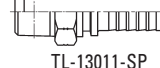

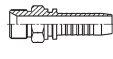
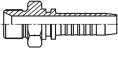



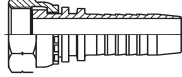
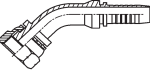
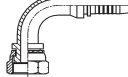
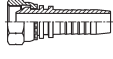
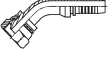
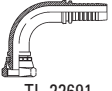

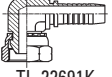
# BASICS ON FITTINGS

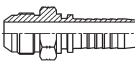
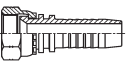
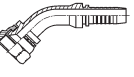
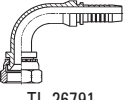
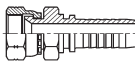

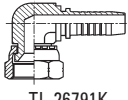

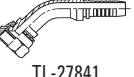
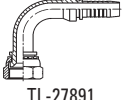
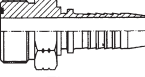
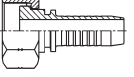
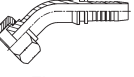
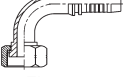
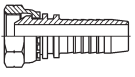
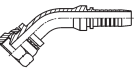
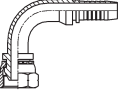
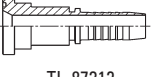

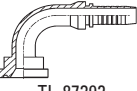

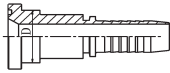
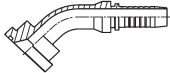

## FITTINGS INDEX

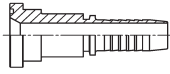
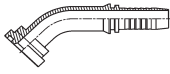
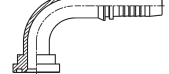
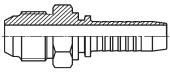
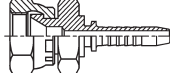
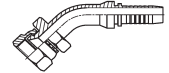
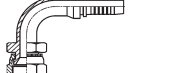
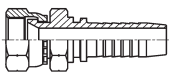
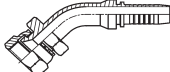
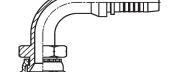
### Swagged fittings-Inserts

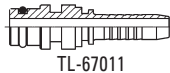
FLAT SEAL	 TL-10311 TL-10312 PAG. D1	 TL-20211-T TL-20212-T PAG. D1	 TL-20241-T TL-20242-T PAG. D1	 TL-20291-T TL-20292-T PAG. D2
60° CONE SEAL	 TL-10611 TL-10612 PAG. D2	 TL-20611-T TL-20612-T PAG. D2	 TL-20641-T TL-20642-T PAG. D3	 TL-20691-T TL-20692-T PAG. D3
MULTISEAL	 TL-20111-T TL-20112-T PAG. D3	 TL-20141-T TL-20142-T PAG. D4	 TL-20191-T TL-20192-T PAG. D4	
74° CONE SEAL	 TL-10711 TL-10712 PAG. D4	 TL-20711-T TL-20712-T PAG. D5	 TL-20741-T TL-20742-T PAG. D5	 TL-20791-T TL-20792-T PAG. D5
90° CONE SEAL	 TL-10811L TL-10811L-LN PAG. D6			
24° CONE O-RING SEAL L.T.	 TL-10411 TL-10412 PAG. D6	 TL-10511 TL-10512 PAG. D6	 TL-20411-T TL-20412-T PAG. D7	 TL-20441-T TL-20442-T PAG. D7
24° CONE O-RING SEAL H.T.	 TL-10511-T TL-10512-T PAG. D8	 TL-20511-T TL-20512-T PAG. D8	 TL-20411-T TL-20412-T PAG. D9	 TL-20541-T TL-20542-T PAG. D9
24° CONE O-RING SEAL L.T.	 TL-20411C-T TL-20412C-T PAG. D10	 TL-20491C-T TL-20492C-T PAG. D10		
24° CONE O-RING SEAL H.T.	 TL-20511C-T TL-20512C-T PAG. D10	 TL-20541C-T TL-20542C-T PAG. D11	 TL-20591C-T TL-20592C-T PAG. D11	
STANDPIPE STRAIGHT	 TL-50011 TL-50012 PAG. D11	 TL-50041 TL-50042 PAG. D12	 TL-50091 TL-50092 PAG. D13	
BSPT	 TL-13011-SP TL-13012-SP PAG. D13			

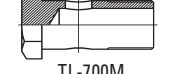
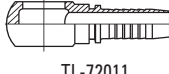
BSP O-RING SEAL	 TL-12211 TL-12212 PAG. D14						
BSP 60° CONE SEAL	 TL-12611 TL-12612 PAG. D14	 TL-12611A TL-12612A PAG. D15	 TL-22111 TL-22112 PAG. D15				
BSP MULTISEAL	 TL-22141 TL-22142 PAG. D16	 TL-22191 TL-22192 PAG. D16					
BSP FLAT SEAL	 TL-22211 TL-22212 PAG. D16	 TL-22241 TL-22242 PAG. D17	 TL-22291 TL-22292 PAG. D17				
BSP 60° CONE SEAL	 TL-22611 TL-22612 PAG. D17	 TL-22641 TL-22642 PAG. D18	 TL-22691 TL-22692 PAG. D19	 TL-22611D TL-22612D PAG. D19	 TL-22611D-SM TL-22612D-SM PAG. D20	 TL-22691K TL-22692K PAG. D20	
SAE O-RING SEAL	 TL-16011 TL-16012 PAG. D20						
NPT	 TL-15611 TL-15612 PAG. D21						
JIC 74° CONE SEAL	 TL-16711 TL-16712 PAG. D22	 TL-26711 TL-26712 PAG. D23	 TL-26741 TL-26742 PAG. D24	 TL-26791 TL-26792 PAG. D25	 TL-26711D TL-26712D PAG. D25	 TL-26711D-SM TL-26712D-SM PAG. D26	 TL-26791K TL-26792K PAG. D26
SAE 90° CONE SEAL	 TL-17811 TL-17812 PAG. D26	 TL-27811 TL-27812 PAG. D27	 TL-27841 TL-27842 PAG. D27	 TL-27891 TL-27892 PAG. D27			
ORFS FLAT SEAL	 TL-14211 TL-14212 PAG. D28	 TL-24211 TL-24211-T PAG. D28	 TL-24241 TL-24241-T PAG. D28	 TL-24291 TL-24291-T PAG. D29			
NPSM 60° CONE SEAL	 TL-21611 TL-21612 PAG. D29	 TL-21641 TL-21642 PAG. D29	 TL-21691 TL-21692 PAG. D30				
SAE FLANGE L.T.	 TL-87312 PAG. D30	 TL-87342 PAG. D31	 TL-87392 PAG. D31				

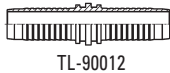

SAE FLANGE H.T.				
	TL-87612 PAG. D32	TL-87642 PAG. D32	TL-87692 PAG. D33	
FLANGE				
	TL-88112 PAG. D33	TL-88142 PAG. D33	TL-88192 PAG. D33	
METRIC 60° CONE SEAL				
	TL-18611 TL-18612 PAG. D34	TL-28611 TL-28612 PAG. D34	TL-28641 TL-28642 PAG. D35	TL-28691 TL-28692 PAG. D35
GAS 60° CONE SEAL				
	TL-29611D TL-29612D PAG. D35	TL-29641D TL-29642D PAG. D36	TL-29691-D TL-29692-D PAG. D36	
METRIC WATERWASH				
	TL-20011-T PAG. D36			
STAPLELOK				
	TL-60011 TL-60012 PAG. D37	TL-67011 TL-67012 PAG. D37		
BANJO				
	TL-70011 TL-70012 PAG. D37	TL-700M PAG. D38	TL-72011 TL-72012 PAG. D38	TL-720B PAG. D39
NPT SWIVEL				
	TL-15611SW PAG. D39			
SAE O-RING BOSS SWIVEL				
	TL-16011SW PAG. D39			
DOUBLE CONNECTION				
	TL-90011 PAG. D40	TL-90012 PAG. D40		

## One-piece fittings

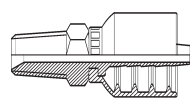

TL-15611-PK  
PAG. D40

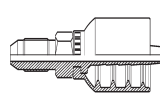

TL-16711-PK  
PAG. D41

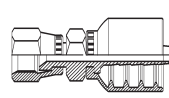

TL-26711-PK  
PAG. D41

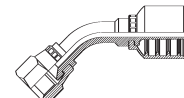



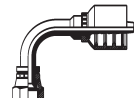











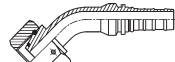
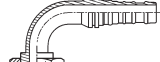

TL-26741-PK  
PAG. D42

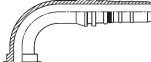

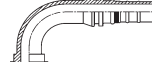
TL-26791-PK  
PAG. D42

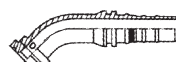
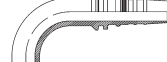
## Interlock fittings

BRITISH	 TL-13013-SP PAG. D42	 TL-12613 PAG. D43	 TL-22613W PAG. D43	 TL-22613-ORW PAG. D43		
NPT	 TL-15613 PAG. D43					
JIC 74° CONE SEAL	 TL-26713-W PAG. D44	 TL-26793-W PAG. D44				
METRIC 24° CONE SEAL H.T.	 TL-10513 PAG. D44	 TL-20513-W TL-20513-T PAG. D45	 TL-2543-W TL-2543-T PAG. D45	 TL-20593-W TL-20593-T PAG. D45		
SAE FLANGE	 TL-87313 PAG. D46	 TL-87343 PAG. D46	 TL-87393 PAG. D46	 TL-87613 PAG. D47	 TL-87643 PAG. D47	 TL-87693 PAG. D47
9000 PSI FLANGE	 TL-87913 PAG. D48	 TL-87943 PAG. D48	 TL-87993 PAG. D48			
DOUBLE CONNECTION	 TL-90013 PAG. D49					

## Reusable fittings

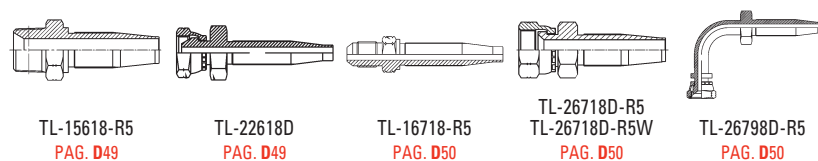

## Low pressure easy lock fittings

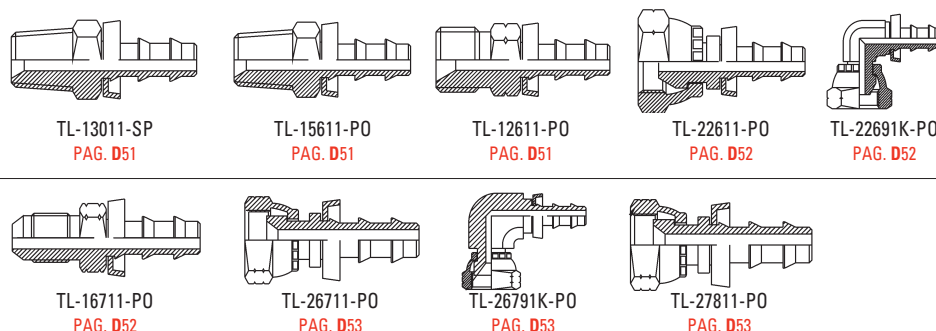

# HOW TO ORDER FITTINGS

MATERIAL	CARBON STEEL	BRASS	STAINLESS STEEL
SIGN	CS	BR	SS

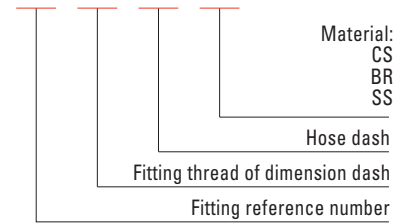

HOSE DN	2	3	5	6	8	10	12	16
HOSE DASH	-01	-02	-03	-04	-05	-06	-08	-10

HOSE DN	20	22	25	32	40	45	50	64
HOSE DASH	-12	-14	-16	-20	-24	-28	-32	-40

THREAD	-02	-04	-05	-06	-08	-10	-12	-16	-20	-24	-32
BSPB	G1/8"x28	G1/4"x19	*	G3/8"x19	G1/2"x14	G5/8"x14	G3/4"x14	G1"x11	G1.1/4"	G1.1/2"	G2"x11
BSPB	R1/8"x28	R1/4"x29	*	R3/8"x19	R1/2"x14	*	R3/4"x14	R1"x11	R1.1/4"x11	R1.1/2"x11	R2"x11
NPT	Z1/8"x27	Z1/4"x18	*	Z3/8"x18	Z1/2"x14	*	Z3/4"x14	Z1"x11.5	Z1.1/4"x11,5	Z1.1/2"x11,5	Z2"x11,5
FLANGE	*	*	*	*	1/2"	*	3/4"	1"	1.1/4"	1.1/2"	2"

HOSE DN	11	12	14	20	22	27	33	41	48	64
HOSE DASH	-07	-08	-09	-12	-14	-17	-21	-26	-30	-40
UNC	7/16"x20	1/2"x 20	9/16"x18	3/4"x16	7/8"x14	1.1/16"x12	1.5/16"x12	1.5/8"x12	1.7/8"x12	2.1/2"x12

## ATTENTION:



- ✓ IN CASE OF BRAIDED HOSES, THE REFERENCE NUMBER OF THE FITTING INSERT ENDS WITH THE DIGIT **1**
- ✓ IN CASE OF SPIRAL HOSES, THE REFERENCE NUMBER OF THE FITTING INSERT ENDS WITH THE DIGIT **2**
- ✓ IN THIS VERSION, THE LENGTH OF THE FITTING'S HOSE BARB IS LONGER THAT THE FIRST VERSION
- ✓ SEE THE FOOTNOTES IN THE TABLES OF THE REFERENCE NUMBER IN QUESTION

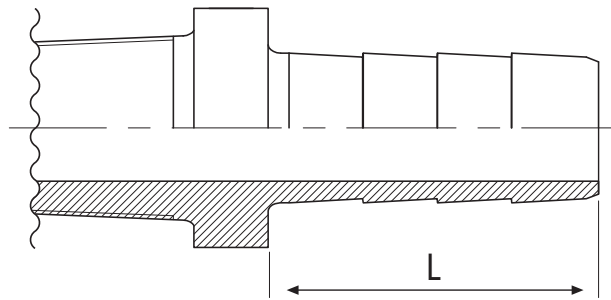

## Braided hoses

Reference number ends with digit **1**

L	DASH									
	04	05	06	08	10	12	16	20	24	22
<b>mm</b>	27,50	29,00	30,00	31,50	34,00	40,00	46,30	54,50	70,00	71,00
<b>inch</b>	1,083	1,142	1,181	1,240	1,339	1,575	1,823	2,146	2,756	2,795

## For spiral hoses

Reference number ends with digit **2**

L	DASH									
	04	05	06	08	10	12	16	20	24	22
<b>mm</b>	30,00	32,00	35,50	36,50	40,00	47,20	56,00	65,00	72,00	76,00
<b>inch</b>	1,181	1,260	1,398	1,437	1,575	1,858	2,205	2,559	2,835	2,992

# SWAGGED FITTINGS - INSERTS

## TL-10311 · TL-10312

Metric. Male. O-ring. Flat seal

PART NO.	THREAD E	HOSE BORE		DIMENSIONS		
		DN	DASH	A	C	S1
TL-10311-12-04	M12X1.25	6	04	22.5	10	14
TL-10311-14-04	M14X1.5	6	04	23.5	11	17
TL-10311-16-05	M16X1.5	8	04	23.5	11	17
TL-10311-18-06	M18X1.5	10	06	23.5	11	19
TL-10311-22-08	M22X1.5	12	08	26.5	12	22
TL-10311-27-10	M27X1.5	16	10	31.5	13	27
TL-10311-30-12	M30X1.5	20	12	33.5	14	32
TL-10311-36-14	M36X2	22	14	35.5	16	38
TL-10311-39-16	M39X2	25	16	39	16	41
TL-10311-45-20	M45X2	32	20	44.5	20	46
TL-10311-52-24	M52X2	40	24	47.5	22	55
TL-10311-64-32	M64X2	50	32	52.5	27	65

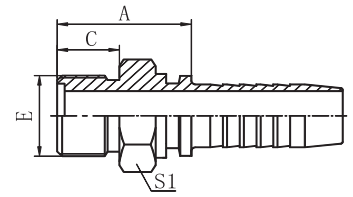

Note: 1. For use with braided hoses. 2. If use with spiral hoses, hose fitting series number is TL-10312-xx-xx.

## TL-20211-T · TL-20212-T

Metric. Female. Flat seal

PART NO.	THREAD E	HOSE BORE		DIMENSIONS		
		DN	DASH	A	C	S2
TL-20211-14-04T	M14X1.5	6	04	14.5	8	17
TL-20211-16-05T	M16X1.5	8	05	15.5	8	19
TL-20211-18-06T	M18X1.5	10	06	16	8.5	22
TL-20211-22-08T	M22X1.5	12	08	16.5	10	27
TL-20211-27-10T	M27X1.5	16	10	20	10.5	32
TL-20211-30-12T	M30X1.5	20	12	22	11	36
TL-20211-36-14T	M36X2	22	14	20	13	41
TL-20211-39-16T	M39X2	25	16	23.2	13	46
TL-20211-45-20T	M45X2	32	20	25	15	55
TL-20211-52-24T	M52X2	40	24	25.5	17	60
TL-20211-64-32T	M64X2	50	32	26	23	75

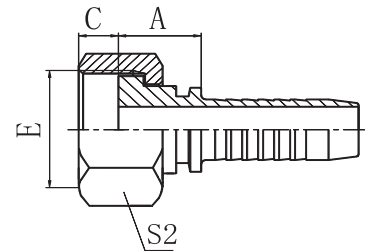

Note: 1. For use with braided hoses. 2. If use with spiral hoses, hose fitting series number is TL-20212-xx-xx.

## TL-20241-T · TL-20242-T

Metric. Female. Flat seal. Elbow 45°

PART NO.	THREAD E	HOSE BORE		DIMENSIONS			
		DN	DASH	A	C	H	S2
TL-20241-14-04T	M14X1.5	6	04	43.5	8	20.5	17
TL-20241-16-05T	M16X1.5	8	05	44.4	8	20	22
TL-20241-18-06T	M18X1.5	10	06	47	8.5	21.5	24
TL-20241-22-08T	M22X1.5	12	08	58.5	10	24	27
TL-20241-27-10T	M27X1.5	16	10	68.6	10.5	24.3	32
TL-20241-36-14T	M36X2	22	14	77.3	13	27	41
TL-20241-39-16T	M39X2	25	16	83.9	13	29.7	46
TL-20241-45-20T	M45X2	32	20	94.5	15	33.8	55
TL-20241-52-24T	M52X2	40	24	108.5	17	39	60
TL-20241-64-32T	M64X2	50	32	127.8	23	45.6	75

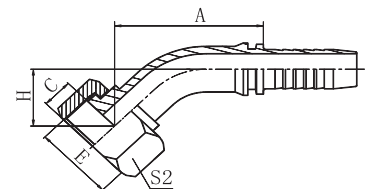

Note: 1. For use with braided hoses. 2. If use with spiral hoses, hose fitting series number is TL-20242-xx-xx.



# TL-20291-T · TL-20292-T

Metric. Female. Flat seal. Elbow 90°

PART NO.	THREAD E	HOSE BORE		DIMENSIONS			
		DN	DASH	A	C	H	S2
TL-20291-14-04T	M14X1.5	6	04	30	8	34	17
TL-20291-16-05T	M16X1.5	8	05	33	8	39	19
TL-20291-18-06T	M18X1.5	10	06	35	8.5	41	22
TL-20291-22-08T	M22X1.5	12	08	41	10	45.5	27
TL-20291-27-10T	M27X1.5	16	10	52	10.5	54	32
TL-20291-30-12T	M30X1.5	20	12	65.5	11	63.5	36
TL-20291-36-14T	M36X2	22	14	71.2	13	61	41
TL-20291-39-16T	M36X2	25	16	76.7	13	67.5	46
TL-20291-45-20T	M45X2	32	20	91.5	15	78.5	55
TL-20291-52-24T	M52X2	40	24	109	17	92	60
TL-20291-64-32T	M64X2	50	32	130.95	23	113.3	75

Note: 1. For use with braided hoses. 2. If use with spiral hoses, hose fitting series number is TL-20292-xx-xx.

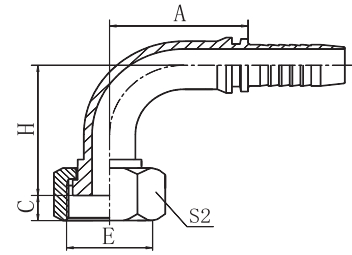

# TL-10611 · TL-10612

Metric. Male. Cone seat 60°

PART NO.	THREAD E	HOSE BORE		DIMENSIONS		
		DN	DASH	A	C	S2
TL-10611-14-04	M14X1.5	6	04	23.5	11	19
TL-10611-16-05	M16X1.5	8	05	26.5	12	22
TL-10611-18-06	M18X1.5	10	06	29	12	24
TL-10611-22-08	M22X1.5	12	08	31.5	14	27
TL-10611-26-10	M26X1.5	16	10	35	16	32
TL-10611-27-10D	M27X1.5	16	10	36	16	32
TL-10611-27-10	M27X2	16	10	36	16	32
TL-10611-30-12D	M30X1.5	20	12	39.5	18	36
TL-10611-30-12D	M30X2	20	12	39.5	18	36
TL-10611-33-16	M33X2	25	16	43.7	20	46
TL-10611-45-20	M45X2	32	20	46	20	55
TL-10611-52-24	M52X2	40	24	46	20	60

Note: 1. For use with braided hoses. 2. If use with spiral hoses, hose fitting series number is TL-10612-xx-xx.

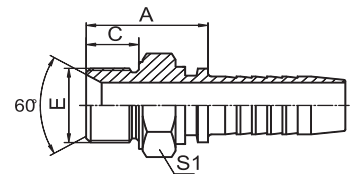

# TL-20611-T · TL-20612-T

Metric. Female. 60° Cone

PART NO.	THREAD E	HOSE BORE		DIMENSIONS		
		DN	DASH	A	C	S2
TL-20611-14-04T	M14X1.5	6	04	18	5.5	19
TL-20611-16-05T	M16X1.5	8	05	19	5.5	22
TL-20611-18-06T	M18X1.5	10	06	20	5.5	22
TL-20611-22-08T	M22X1.5	12	08	22.5	6	27
TL-20611-27-10DT	M27X1.5	16	10	25.5	6	32
TL-20611-27-10T	M27X2	16	10	25.5	6	32
TL-20611-30-12T	M30X2	20	12	27	6	36
TL-20611-39-16T	M39X2	25	16	31.7	6.5	46
TL-20611-45-20T	M45X2	32	20	31.5	8.5	50
TL-20611-52-24T	M52X2	40	24	32	10	60

Note: 1. For use with braided hoses. 2. If use with spiral hoses, hose fitting series number is TL-20612-xx-xx.

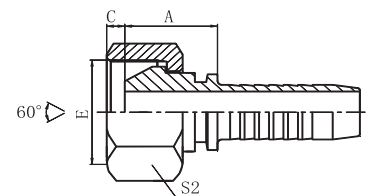

## TL-20641-T · TL-20642-T

Metric. Female. Elbow 45°. 60° Cone

PART NO.	THREAD E	HOSE BORE		DIMENSIONS			
		DN	DASH	A	C	H	S2
TL-20641-14-04T	M14X1.5	6	04	42.5	5.5	20.5	17
TL-20641-16-05T	M16X1.5	8	05	45	5.5	22	19
TL-20641-18-06T	M18X1.5	10	06	48	5.5	23	22
TL-20641-22-08T	M22X1.5	12	08	61.5	6	27	27
TL-20641-27-10DT	M27X1.5	16	10	74.5	6	29.5	32
TL-20641-30-12DT	M30X1.5	20	12	82	6	33.5	36
TL-20641-36-14DT	M36X2	22	14	81.9	6.5	31.6	41
TL-20641-39-16T	M39X2	25	16	88.5	6.5	34.3	46
TL-20641-45-20T	M45X2	32	20	99.1	8.5	38.4	55
TL-20641-52-24T	M52X2	40	24	113.4	10	42.7	60

Note: 1. For use with braided hoses. 2. If use with spiral hoses, hose fitting series number is TL-20642-xx-xx.

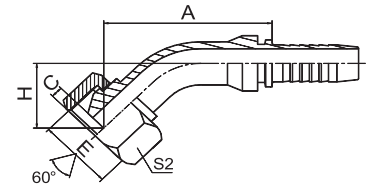

## TL-20691-T · TL-20692-T

Metric. Female. Elbow 90°. 60° Cone

PART NO.	THREAD E	HOSE BORE		DIMENSIONS			
		DN	DASH	A	C	H	S2
TL-20691-14-04T	M14X1.5	6	04	30	5.5	37	17
TL-20691-16-05T	M16X1.5	8	05	33	5.5	40.5	19
TL-20691-18-06T	M18X1.5	10	06	35	5.5	44	22
TL-20691-22-08T	M22X1.5	12	08	41	6	52	27
TL-20691-27-10DT	M27X1.5	16	10	56	6	55.5	32
TL-20691-30-12DT	M30X1.5	20	12	66	6	68	36
TL-20691-36-14T	M36X2	22	14	71.2	6.5	67.5	41
TL-20691-39-16T	M39X2	25	16	76.7	6.5	74	46
TL-20691-45-20T	M45X2	32	20	92	8.5	85	50
TL-20691-52-24T	M52X2	40	24	109.4	10	99	60

Note: 1. For use with braided hoses. 2. If use with spiral hoses, hose fitting series number is TL-20692-xx-xx.

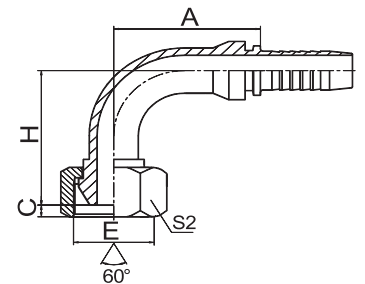

## TL-20111-T · TL-20112-T

Metric. Female. Multiseal

PART NO.	THREAD E	HOSE BORE		DIMENSIONS		
		DN	DASH	A	C	S2
TL-20111-14-04T	M14X1.5	6	04	19.5	4	19
TL-20111-16-05T	M16X1.5	8	05	20	4.5	22
TL-20111-18-06T	M18X1.5	10	06	20	4.5	22
TL-20111-20-06T	M20X1.5	10	06	20.5	5.5	24
TL-20111-22-08T	M22X1.5	12	08	21.5	5	27
TL-20111-24-08T	M24X1.5	12	08	22	5.5	30
TL-20111-27-10DT	M27X1.5	16	10	24.5	4.5	32
TL-20111-27-10T	M27X2	16	10	24.5	4.5	32
TL-20111-30-12T	M30X2	20	12	26	6	36
TL-20111-36-14T	M36X2	22	14	27.5	5	41
TL-2011-39-16T	M39X2	25	16	30.7	5	46
TL-2011-45-20T	M45X2	32	20	34.5	5	50
TL-2011-52-24T	M52X2	40	24	36	5	60
TL-2011-64-32T	M64X2	50	32	42	8	75

Note: 1. For use with braided hoses. 2. If use with spiral hoses, hose fitting series number is TL-20112-xx-xx.

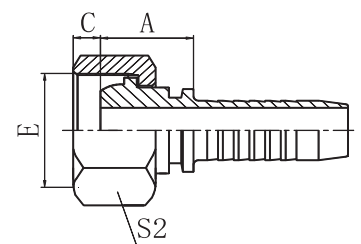

# TL-20141-T · TL-20142-T

Metric. Female. Elbow 45°. Multiseal

PART NO.	THREAD E	HOSE BORE		DIMENSIONS			
		DN	DASH	A	C	H	S2
TL-20141-14-04T	M14X1.5	6	04	43.5	4	21.5	17
TL-20141-16-05T	M16X1.5	8	05	46	4.5	22.5	19
TL-20141-18-06T	M18X1.5	10	06	49	4.5	24	22
TL-20141-20-06T	M20X1.5	10	06	49	5.5	24	27
TL-20141-22-08T	M22X1.5	12	08	61	5	26	27
TL-20141-24-08T	M24X1.5	12	08	61	5.5	27	30
TL-20141-27-10DT	M27X1.5	16	10	74.5	4.5	29.5	32
TL-20141-27-10T	M27X2	16	10	74.5	4.5	29.5	32
TL-20141-30-12T	M30X2	20	12	81.5	6	33.5	36
TL-20141-39-16T	M39X2	25	16	88.7	5	34	46
TL-20141-45-20T	M45X2	32	20	99.5	5	38.5	55
TL-20141-52-24T	M52X2	40	24	114.5	5	43.5	60

Note: 1. For use with braided hoses. 2. If use with spiral hoses, hose fitting series number is TL-20142-xx-xx.

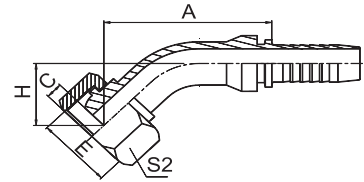

# TL-20191-T · TL-20192-T

Metric. Female. Elbow 90°. Multiseal

PART NO.	THREAD E	HOSE BORE		DIMENSIONS			
		DN	DASH	A	C	H	S2
TL-20191-14-04T	M14X1.5	6	04	30	4	38	17
TL-20191-16-05T	M16X1.5	8	05	33	4.5	41.5	19
TL-20191-18-06T	M18X1.5	10	06	35	4.5	45	22
TL-20191-20-06T	M20X1.5	10	06	35	5.5	45	24
TL-20191-22-08T	M22X1.5	12	08	41	5	52.5	27
TL-20191-24-08T	M24X1.5	12	08	41	5.5	51	30
TL-20191-27-10DT	M27X1.5	16	10	56	4.5	55.5	32
TL-20191-27-10T	M27X2	16	10	56	4.5	55.5	32
TL-20191-30-12T	M30X2	20	12	66	6	68	36
TL-20191-39-16T	M39X2	25	16	76.7	5	73.5	46
TL-20191-45-20T	M45X2	32	20	91.5	5	85	55
TL-20191-52-24T	M52X2	40	24	109	5	100	60
TL-20191-64-32T	M64X2	50	32	132	8	127	75

Note: 1. For use with braided hoses. 2. If use with spiral hoses, hose fitting series number is TL-20192-xx-xx.

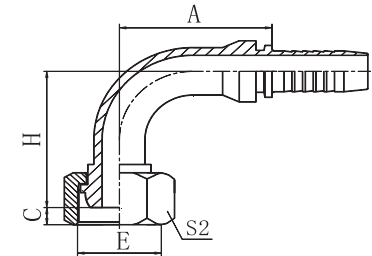

# TL-10711 · TL-10712

Metric. Male. 74° Cone. GB

PART NO.	THREAD E	HOSE BORE		DIMENSIONS		
		DN	DASH	A	C	S1
TL-10711-12-03	M12X1.5	5	03	26.5	15.7	14
TL-10711-14-04	M14X1.5	6	04	30.5	18	17
TL-10711-16-05	M16X1.5	8	05	31.5	19	17
TL-10711-18-06	M18X1.5	10	06	32	19	19
TL-10711-22-08	M22X1.5	12	08	35	19.5	22
TL-10711-24-08	M24X1.5	12	08	37	20	24
TL-10711-27-10	M27X1.5	16	10	37.5	20	27
TL-10711-30-12	M30X1.5	20	12	42	23	32
TL-10711-36-14	M36X2	22	14	45	26	38
TL-10711-39-16	M39X2	25	16	48.7	27.5	41
TL-10711-45-20	M45X2	32	20	52	28.5	46

Note: 1. For use with braided hoses. 2. If use with spiral hoses, hose fitting series number is TL-10712-xx-xx.

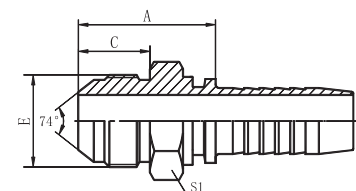

# TL-20711-T · TL-20712-T

Metric. Female. 74° Cone. GB

PART NO.	THREAD E	HOSE BORE		DIMENSIONS		
		DN	DASH	A	C	S2
TL-20711-14-04T	M12X1.5	6	04	14	8	17
TL-20711-16-05T	M14X1.5	8	05	15	8	19
TL-20711-18-06T	M16X1.5	10	06	16	8.5	22
TL-20711-20-06T	M18X1.5	10	06	16.5	10	24
TL-20711-22-08T	M22X1.5	12	08	17	10	27
TL-20711-24-08T	M24X1.5	12	08	18.5	10	30
TL-20711-27-10T	M27X1.5	16	10	19	10.5	32
TL-20711-33-12T	M30X1.5	20	12	20.5	13	41
TL-20711-36-14T	M36X2	22	14	20	13	41
TL-20711-39-16T	M39X2	25	16	23.2	13	46
TL-20711-45-20T	M45X2	32	20	25.5	15	50

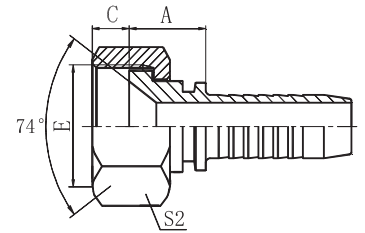

Note: 1. For use with braided hoses. 2. If use with spiral hoses, hose fitting series number is TL-20712-xx-xx.

# TL-20741-T · TL-20742-T

Metric. Female. 74° Cone. GB

PART NO.	THREAD E	HOSE BORE		DIMENSIONS			
		DN	DASH	A	C	H	S2
TL-20741-14-04T	M14X1.5	6	04	40.5	8	18.5	17
TL-20741-16-05T	M16X1.5	8	05	44	8	20	19
TL-20741-18-06T	M18X1.5	10	06	46	8.5	21.5	22
TL-20741-22-08T	M22X1.5	12	08	59	10	24	27
TL-20741-27-10T	M27X1.5	16	10	69	10.5	24	32
TL-20741-30-12T	M30X1.5	20	12	75.5	13	27.5	36
TL-20741-33-12T	M33X2	20	12	75.5	13	27.5	41
TL-20741-36-14T	M36X2	22	14	79.8	13	29.6	41
TL-20741-39-16T	M39X2	25	16	84.7	13	30	46
TL-20741-45-20T	M45X2	32	20	97	15	36.2	55
TL-20741-52-24T	M52X2	40	24	112.9	17	40.9	60

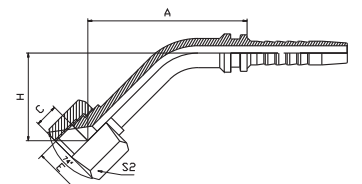

Note: 1. For use with braided hoses. 2. If use with spiral hoses, hose fitting series number is TL-20742-xx-xx.

# TL-20791-T · TL-20792-T

Metric. Female. 74° Cone. GB

PART NO.	THREAD E	HOSE BORE		DIMENSIONS			
		DN	DASH	A	C	H	S2
TL-20791-14-04T	M14X1.5	6	04	30	8	34	17
TL-20791-16-05T	M16X1.5	8	05	33	8	38	19
TL-20791-18-06T	M18X1.5	10	06	35	8.5	41	22
TL-20791-22-08T	M22X1.5	12	08	41	10	48	27
TL-20791-27-10T	M27X1.5	16	10	56	10.5	55.5	32
TL-20791-30-12T	M30X1.5	20	12	65	13	63.5	36
TL-20791-36-14T	M36X2	22	14	64	13	64.5	41
TL-20791-39-16T	M39X2	25	16	76.7	13	70.5	46
TL-20791-45-20T	M45X2	32	20	91.5	15	83	55
TL-20791-52-20T	M52X2	32	20	93	17	84.5	60
TL-20791-52-24T	M52X2	40	24	110.7	17	96.5	60

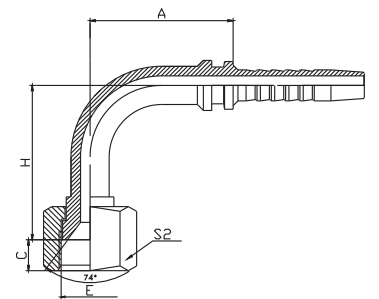

Note: 1. For use with braided hoses. 2. If use with spiral hoses, hose fitting series number is TL-20792-xx-xx.

## TL-10811L · TL-10811L-LN

Metric. Male. 90° Cone seat  
Metric. Male. 90° Cone seat. Lock Nut

PART NO.	THREAD E	HOSE BORE		DIMENSIONS			
		DN	DASH	A	C	S1	S2
TL-10811L-12-04	M12X1.5	6	04	46	34	17	17
TL-10811L-12-04A	M12X1	6	04	44.5	32.5	17	17
TL-10811L-14-04	M14X1.5	6	04	46	34	17	19
TL-10811L-14-06	M14X1.5	10	06	46	34	17	19
TL-10811L-16-04	M16X1.5	6	04	46.5	34	19	22
TL-10811L-16-06	M16X1.5	10	06	46.5	34	22	22
TL-10811L-20-06	M20X1.5	10	6	57	40	27	27
TL-10811L-20-08	M20X1.5	12	08	57.5	40	27	27
TL-10811L-22-08	M22X1.5	12	08	62.5	45	27	27

Note: If you are interested to order the fitting with lock nut, please insert suffix "LN" after our part no. for example TL-10811L-12-04LN.

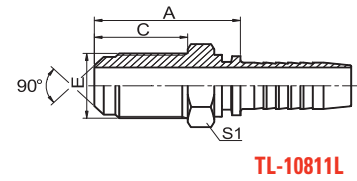

TL-10811L

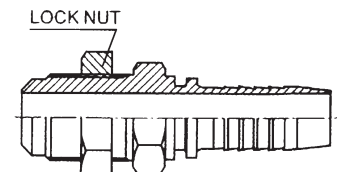

TL-10811L-LN

## TL-10411 · TL-10412

Metric. Male. 24° Cone seat LT. DIN 3861 - ISO 8434-1

PART NO.	THREAD E	HOSE BORE		HOSE O.D.	DIMENSIONS		
		DN	DASH		A	C	S1
TL-10411-12-04	M12X1.5	6	04	6	20.5	10	12
TL-10411-14-04	M14X1.5	6	04	8	23.5	11	14
TL-10411-14-05	M14X1.5	8	05	8	23.5	11	14
TL-10411-16-04	M16X1.5	6	04	10	23.5	11	17
TL-10411-16-05	M16X1.5	8	05	10	23.5	11	17
TL-10411-16-06	M16X1.5	10	06	10	23.5	11	17
TL-10411-18-05	M18X1.5	8	05	12	25	11	19
TL-10411-18-06	M18X1.5	10	06	12	25	11	19
TL-10411-22-06	M22X1.5	10	06	15	26.5	12	24
TL-10411-22-08	M22X1.5	12	08	15	27	12	24
TL-10411-26-08	M26X1.5	12	08	18	28	12	27
TL-10411-26-10	M26X1.5	16	10	18	28.5	12	27
TL-10411-27-10	M27X1.5	16	10	18	29.5	13	30
TL-10411-30-10	M30X2	16	10	22	32.5	16	32
TL-10411-30-12	M30X2	20	12	22	33	16	32
TL-10411-36-16	M36X2	25	16	28	39.2	18	41
TL-10411-45-20	M45X2	32	20	35	41.5	18	46
TL-10411-52-24	M52X2	40	24	42	44	18	55

Note: 1. For use with braided hoses. 2. If use with spiral hoses, hose fitting series number is TL-10412-xx-xx.

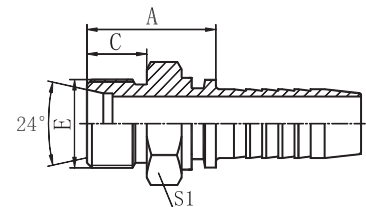

## TL-10511 · TL-10512

Metric. Male. 24° Cone seat HT. DIN 3861 - ISO 8434-2

PART NO.	THREAD E	HOSE BORE		HOSE O.D.	DIMENSIONS		
		DN	DASH		A	C	S1
TL-10511-14-04	M14X1.5	6	04	6	24.5	12	14
TL-10511-16-04	M16X1.5	6	04	8	26.5	12	17
TL-10511-18-04	M18X1.5	6	04	10	26.5	12	19
TL-10511-20-05	M20X1.5	8	05	12	27	12	22
TL-10511-20-06	M20X1.5	10	06	12	27	12	22
TL-10511-22-05	M22X1.5	8	05	14	30.5	14	24

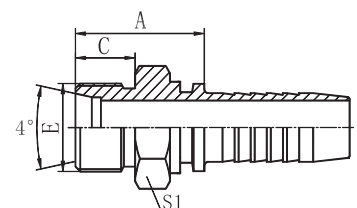

NEXT >

## TL-10511 · TL-10512

Metric. Male. 24° Cone seat HT. DIN 3861 - ISO 8434-2

PART NO.	THREAD E	HOSE BORE		HOSE O.D.	DIMENSIONS		
		DN	DASH		A	C	S1
TL-10511-22-06	M22X1.5	10	06	14	30.5	14	24
TL-10511-22-08	M22X1.5	12	08	14	31	14	24
TL-10511-24-08	M24X1.5	12	08	16	31.5	14	27
TL-10511-30-10	M30X2	16	10	20	36	18	32
TL-10511-30-12	M30X2	20	12	20	36.5	18	32
TL-10511-36-12	M36X2	20	12	25	40.5	20	38
TL-10511-36-16	M36X2	25	16	25	42.2	20	38
TL-10511-42-16	M42X2	25	16	30	43.2	21	46
TL-10511-42-20	M42X2	32	20	30	44	21	46
TL-10511-52-20	M52X2	32	20	30	48.5	22	55

Note: 1. For use with braided hoses. 2. If use with spiral hoses, hose fitting series number is TL-10412-xx-xx.

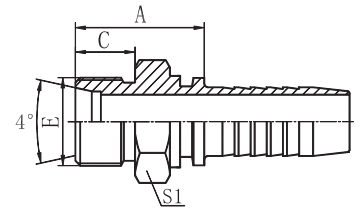

## TL-20411-T · TL-20412-T

Metric. Female. 24° Cone seat LT. DIN 3861 - ISO 8434-2

PART NO.	THREAD E	HOSE BORE		TUBE O.D.	O-RING	DIMENSIONS		
		DN	DASH			A	C	S2
TL-20411-12-04	M12X1.5	6	04	6	O04.5X1.5	26	1.5	17
TL-20411-14-04T	M14X1.5	6	04	8	O06.5X1.5	27.5	2	17
TL-20411-16-05T	M16X1.5	8	05	10	O08.0X1.5	27.5	2	19
TL-20411-16-06	M16X1.5	10	06	10	O08.0X1.5	28	3	22
TL-20411-18-06T	M18X1.5	10	06	12	O10.0X1.5	28	2.5	22
TL-20411-22-08T	M22X1.5	12	08	15	O12.0X2.0	30	3	27
TL-20411-26-10T	M26X1.5	16	10	18	O15.0X2.0	28	2.5	32
TL-20411-30-12T	M30X2	20	12	22	O20.0X2.0	38	5	36
TL-20411-36-16T	M36X2	25	16	28	O26.0X2.0	36.2	4.5	41
TL-20411-45-20T	M45X2	32	20	35	O32.0X2.5	42	5	50
TL-20411-52-24T	M52X2	40	24	42	O38.0X2.5	44	6	60

Note: 1. For use with braided hoses. 2. If use with spiral hoses, hose fitting series number is TL-20412-xx-xx.

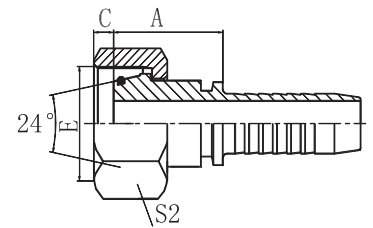

## TL-20441-T · TL-20442-T

Metric. Female. Elbow 45°. 24° Cone seat LT. DIN 3865 - ISO 12151-2

PART NO.	THREAD E	HOSE BORE		TUBE O.D.	O-RING	DIMENSIONS			
		DN	DASH			A	C	H	S2
TL-20441-14-04T	M14X1.5	6	04	8	O06.5X1.5	44	2	21	17
TL-20441-16-05T	M16X1.5	8	05	10	O08.5X1.5	45.5	2	21	19
TL-20441-18-04T	M18X1.5	6	04	12	O10.0X1.5	45	2.5	21.5	22
TL-20441-18-06T	M18X1.5	10	06	12	O10.0X1.5	50	2.5	24.5	22
TL-20441-22-08T	M22X1.5	12	08	15	O12.0X2.0	56	3	26	27
TL-20441-26-10T	M26X1.5	16	10	18	O15.0X2.0	65	2.5	28	32
TL-20441-30-12T	M30X2	20	12	22	O20.0X2.0	72.5	5	32	36
TL-20441-36-12T	M36X2	20	12	28	O26.0X2.0	72.5	4.5	33	41
TL-20441-45-20T	M45X2	32	20	35	O32.0X2.5	99.6	5	40.8	55
TL-20441-52-24T	M52X2	40	24	42	O38.0X2.5	117	6	45.8	60

Note: 1. For use with braided hoses. 2. If use with spiral hoses, hose fitting series number is TL-20442-xx-xx.

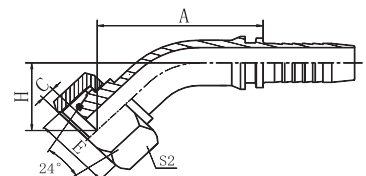

## TL-20491-T · TL-20492-T

Metric. Female. Elbow 90°. 24° Cone seat LT. DIN 3865 - ISO 12151-2

PART NO.	THREAD E	HOSE BORE		TUBE O.D.	O-RING	DIMENSIONS			
		DN	DASH			A	C	H	S2
TL-20491-12-04	M12X1.5	6	04	6	O04.5X1.5	30	1.5	41.5	17
TL-20491-14-04T	M14X1.5	6	04	8	O06.5X1.5	30	2	33	17
TL-20491-16-06	M16X1.5	10	06	10	O08.0X1.5	35.3	2	51.8	22
TL-20491-18-06T	M18X1.5	10	06	12	O10.0X1.5	35	2.5	40	22
TL-20491-22-08T	M22X1.5	12	08	15	O12.0X2.0	43	3	48	27
TL-20491-26-10T	M26X1.5	16	10	18	O15.0X2.0	54	2.5	54	32
TL-20491-30-12T	M30X2	20	12	22	O20.0X2.0	59.5	5	61	36
TL-20491-36-12T	M36X2	20	12	28	O26.0X2.0	59.5	4.5	61.5	41
TL-20491-45-20T	M45X2	32	20	35	O32.0X2.5	91.5	5	88.5	55
TL-20491-52-24T	M52X2	40	24	42	O38.0X2.5	109.4	6	104	60

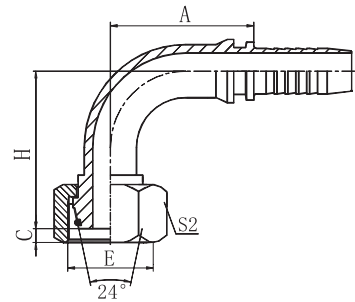

Note: 1. For use with braided hoses. 2. If use with spiral hoses, hose fitting series number is TL-20492-xx-xx.

## TL-20511-T · TL-20512-T

Metric. Female. O-ring. 24° Cone seat HT. DIN 3865 - ISO 12151-2

PART NO.	THREAD E	HOSE BORE		TUBE O.D.	O-RING	DIMENSIONS		
		DN	DASH			A	C	S2
TL-20511-14-04T	M14X1.5	6	04	6	O04.5X1.5	25.5	2	17
TL-20511-16-04T	M16X1.5	6	04	8	O06.5X1.5	27.5	2	19
TL-20511-18-04T	M18X1.5	6	04	10	O08.0X1.5	26.5	2	22
TL-20511-18-06T	M18X1.5	10	06	10	O08.0X1.5	26	2	24
TL-20511-20-06T	M20X1.5	10	06	12	O10.0X1.5	28.5	4	24
TL-20511-22-08T	M22X1.5	12	08	14	O11.0X2.0	29	3	27
TL-20511-24-08T	M24X1.5	12	08	16	O13.0X2.0	30	3	30
TL-20511-30-10T	M30X2	16	10	20	O16.3X2.0	36	5	36
TL-20511-36-12T	M36X2	20	12	25	O20.3X2.4	36	3	41
TL-20511-42-16T	M42X2	25	16	30	O25.3X2.4	39.7	5	50
TL-20511-52-24T	M52X2	40	24	38	O33.3X2.4	44	6.5	60

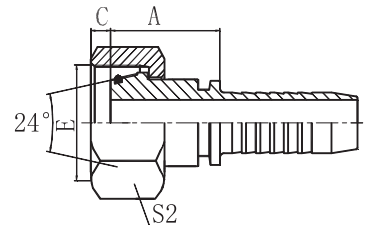

Note: 1. For use with braided hoses. 2. If use with spiral hoses, hose fitting series number is TL-20512-xx-xx.

## TL-10511-T · TL-10512-T

Metric. Male. 24° Cone seat HT. DIN 3861 - ISO 8434-1

PART NO.	THREAD E	HOSE BORE		HOSE O.D.	DIMENSIONS		
		DN	DASH		A	C	S1
TL-10511-14-04	M14X1.5	6	04	6	24.5	12	14
TL-10511-16-04	M16X1.5	6	04	8	26.5	12	17
TL-10511-18-04	M18X1.5	6	04	10	26.5	12	19
TL-10511-20-05	M20X1.5	8	05	12	27	12	22
TL-10511-20-06	M20X1.5	10	06	12	27	12	22
TL-10511-22-05	M22X1.5	8	05	14	30.5	14	24
TL-10511-22-06	M22X1.5	10	06	14	30.5	14	24
TL-10511-22-08	M22X1.5	12	08	14	31	14	24
TL-10511-24-08	M24X1.5	12	08	16	31.5	14	27
TL-10511-30-10	M30X2	16	10	20	36	18	32
TL-10511-30-12	M30X2	20	12	20	36.5	18	32
TL-10511-36-12	M36X2	20	12	25	40.5	20	38
TL-10511-36-16	M36X2	25	16	25	42.2	20	38
TL-10511-42-16	M42X2	25	16	30	43.2	21	46
TL-10511-42-20	M42X2	32	20	30	44	21	46
TL-10511-52-20	M52X2	32	20	30	48.5	22	55

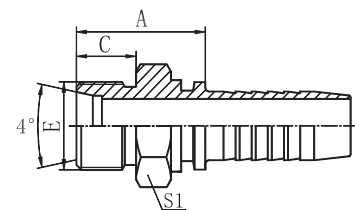

Note: 1. For use with braided hoses. 2. If use with spiral hoses, hose fitting series number is TL-10512-xx-xx.

## TL-20411-T · TL-20412-T

Metric. Female. O-ring. 24° Cone seat LT. DIN 3865 - ISO 12151-2

PART NO.	THREAD E	HOSE BORE		TUBE O.D.	O-RING	DIMENSIONS		
		DN	DASH			A	C	S2
TL-20411-12-04	M12X1.5	6	04	6	O04.5X1.5	26	1.5	17
TL-20411-14-04T	M14X1.5	6	04	8	O06.5X1.5	27.5	2	17
TL-20411-16-05T	M16X1.5	8	05	10	O08.0X1.5	27.5	2	19
TL-20411-16-06	M16X1.5	10	06	10	O08.0X1.5	28	3	22
TL-20411-18-06T	M18X1.5	10	06	12	O10.0X1.5	28	2.5	22
TL-20411-22-08T	M22X1.5	12	08	15	O12.0X2.0	30	3	27
TL-20411-26-10T	M26X1.5	16	10	18	O15.0X2.0	28	2.5	32
TL-20411-30-12T	M30X2	20	12	22	O20.0X2.0	38	5	36
TL-20411-36-16T	M36X2	25	16	28	O26.0X2.0	36.2	4.5	41
TL-20411-45-20T	M45X2	32	20	35	O32.0X2.5	42	5	50
TL-20411-52-24T	M52X2	40	24	42	O38.0X2.5	44	6	60

Note: 1. For use with braided hoses. 2. If use with spiral hoses, hose fitting series number is TL-20412-xx-xx.

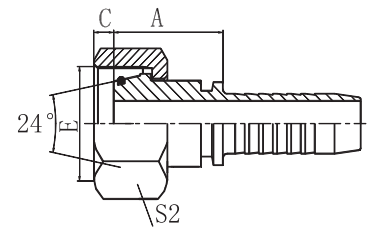

## TL-20541-T · TL-20542-T

Metric. Female. Elbow 45°. O-ring. 24° Cone seat HT. DIN 3865 - ISO 12151-2

PART NO.	THREAD E	HOSE BORE		TUBE O.D.	O-RING	DIMENSIONS			
		DN	DASH			A	C	H	S2
TL-20541-14-04T	M14X1.5	6	04	6	O04.5X1.5	44	2	21	17
TL-20541-16-04T	M16X1.5	6	04	8	O06.5X1.5	44	2	21	19
TL-20541-18-04T	M18X1.5	6	04	10	O08.0X1.5	44	2	21	22
TL-20541-18-06T	M18X1.5	10	06	10	O08.0X1.5	48.5	2	23	22
TL-20541-20-06T	M20X1.5	10	06	12	O10.0X1.5	50	4	24.5	24
TL-20541-22-08T	M22X1.5	12	08	14	O11.0X2.0	55.5	3	26	27
TL-20541-24-08T	M24X1.5	12	08	16	O13.0X2.0	56.5	3	27	30
TL-20541-30-10T	M30X2	16	10	20	O16X2.0	63.5	5	31	36
TL-20541-36-12T	M36X2	20	12	25	O20.3X2.4	73.5	3	34	41
TL-20541-42-16T	M42X2	25	16	30	O25.3X2.4	92.3	5	36.8	50
TL-20541-52-24T	M52X2	40	24	38	O33.3X2.4	115.9	6.5	45.1	60

Note: 1. For use with braided hoses. 2. If use with spiral hoses, hose fitting series number is TL-20542-xx-xx.

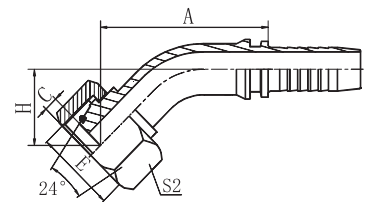

## TL-20591-T · TL-20592-T

Metric. Female. Elbow 90°. O-ring. 24° Cone seat LT. DIN 3865 - ISO 12151-2

PART NO.	THREAD E	HOSE BORE		TUBE O.D.	O-RING	DIMENSIONS			
		DN	DASH			A	C	H	S2
TL-20591-14-04T	M14X1.5	6	04	6	O04.5X1.5	30	2	33	17
TL-20591-16-04T	M16X1.5	6	04	8	O06.5X1.5	30	2	33	19
TL-20591-18-05T	M18X1.5	8	05	10	O08.0X1.5	33	2	37	22
TL-20591-20-06T	M20X1.5	10	06	12	O10.0X1.5	35	4	40	24
TL-20591-22-08T	M22X1.5	12	08	14	O11.0X2.0	43	3	46	27
TL-20591-24-08T	M24X1.5	12	08	16	O13.0X2.0	43	3	48	30
TL-20591-30-10T	M30X2	16	10	20	O16.3X2.0	50	5	55	36
TL-20591-36-12T	M36X2	20	12	25	O20.3X2.4	59.5	3	64	41
TL-20591-42-16T	M42X2	25	16	30	O25.3X2.4	78	5	77.5	50
TL-20591-52-24T	M52X2	40	24	38	O33.3X2.4	109.4	6.5	103	60

Note: 1. For use with braided hoses. 2. If use with spiral hoses, hose fitting series number is TL-20592-xx-xx.

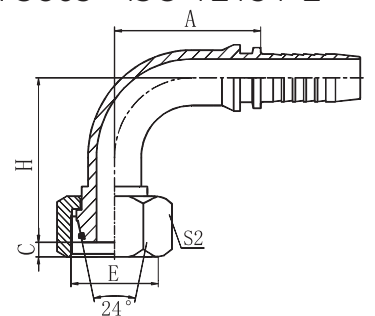



# TL-20411C-T · TL-20412C-T

Metric. Female. Multiseal LT

PART NO.	THREAD E	HOSE BORE		HOSE O.D.	DIMENSIONS		
		DN	DASH		A	C	S2
TL-20411C-12-04T	M12X1.5	6	04	6	18.5	3.5	17
TL-20411C-14-04T	M14X1.5	6	04	8	25.5	4	17
TL-20411C-16-05T	M16X1.5	8	05	10	22.5	3	19
TL-20411C-16-06T	M16X1.5	10	06	10	21.5	4	22
TL-20411C-18-06T	M18X1.5	10	06	12	23	4	22
TL-20411C-22-08T	M22X1.5	12	08	15	25.5	3	27
TL-20411C-26-10T	M26X1.5	16	10	18	26	4.5	32
TL-20411C-30-12T	M30X2	20	12	22	27	7	36
TL-20411C-36-16T	M36X2	25	16	28	32.2	6	41
TL-20411C-45-20T	M45X2	32	20	35	33	7	55
TL-20411C-52-24T	M52X2	40	24	42	34	8	60

Note: 1. For use with braided hoses. 2. If use with spiral hoses, hose fitting series number is TL-20411C-xx-xx.

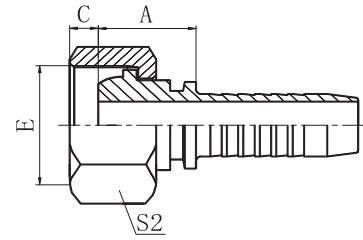

# TL-20491C-T · TL-20492C-T

Metric. Female. Elbow 90°. Multiseal LT

PART NO.	THREAD E	HOSE BORE		TUBE O.D.	DIMENSIONS			
		DN	DASH		A	C	H	S2
TL-20491C-12-04T	M12X1.5	6	04	6	30	3.5	37	17
TL-20491C-14-04T	M14X1.5	6	04	8	30	3	33	17
TL-20491C-16-05T	M16X1.5	8	05	10	33	3	37	19
TL-20491C-16-06T	M16X1.5	10	06	10	35	4	45.2	22
TL-20491C-18-06T	M18X1.5	10	06	12	35	4	40	22
TL-20491C-22-08T	M22X1.5	12	08	15	43	3	48	27
TL-20491C-26-10T	M26X1.5	16	10	18	54	4.5	54	32
TL-20491C-30-12T	M30X2	20	12	22	59.5	7	60	36
TL-20491C-38-16T	M38X2	25	16	30	76.7	5	73.5	46

Note: 1. For use with braided hoses. 2. If use with spiral hoses, hose fitting series number is TL-20492C-xx-xx.

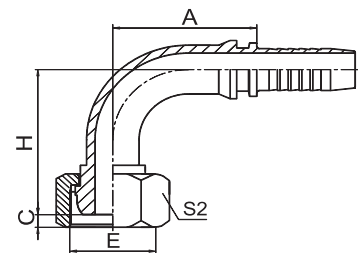

# TL-20511C-T · TL-20512C-T

Metric. Female. Multiseal HT

PART NO.	THREAD E	HOSE BORE		TUBE O.D.	DIMENSIONS		
		DN	DASH		A	C	S2
TL-20511C-16-04T	M18X1.5	6	04	8	21	3	19
TL-20511C-18-04T	M20X1.5	6	04	10	21	3	22
TL-20511C-20-05T	M20X1.5	8	05	12	24.5	5	24
TL-20511C-22-08T	M22X1.5	12	08	14	24	3	27
TL-20511C-24-08T	M24X1.5	12	08	16	25.5	4	30
TL-20511C-30-10T	M30X2	16	10	20	27	6	36
TL-20511C-36-12T	M36X2	20	12	25	29	6	41
TL-20511C-42-16T	M42X2	25	16	30	36.2	7	50
TL-20511C-52-20T	M52X2	32	20	38	47.5	9	60

Note: 1. For use with braided hoses. 2. If use with spiral hoses, hose fitting series number is TL-20512C-xx-xx.

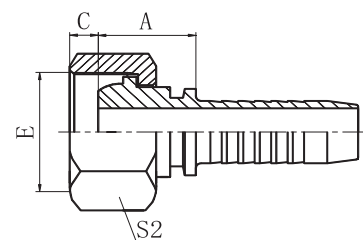

## TL-20541C-T · TL-20542C-T

Metric. Female. Elbow 45°. Multiseal LT

PART NO.	THREAD E	HOSE BORE		TUBE O.D.	DIMENSIONS			
		DN	DASH		A	C	H	S2
TL-20541C-18-04T	M18X1.5	6	04	10	43.7	3	21.6	22
TL-20541C-20-06T	M20X1.5	10	06	12	48.9	4.5	24.6	24
TL-20541C-24-08T	M24X1.5	12	08	16	56.5	4	26.5	30

Note: 1. For use with braided hoses. 2. If use with spiral hoses, hose fitting series number is TL-20542C-xx-xx.

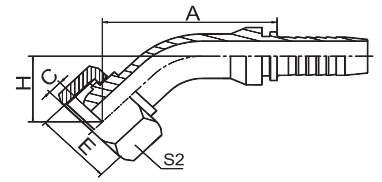

## TL-20591C-T · TL-20592C-T

Metric. Female. Elbow 45°. Multiseal LT

PART NO.	THREAD E	HOSE BORE		TUBE O.D.	DIMENSIONS			
		DN	DASH		A	C	H	S2
TL-20591C-18-04T	M18X1.5	6	04	10	30	3	38.5	22
TL-20591C-20-06T	M20X1.5	10	06	12	35	5	39	24
TL-20591C-24-08T	M24X1.5	12	08	16	43	4	47	30
TL-20591C-30-10T	M30X2	16	10	20	56.5	7	56.5	36
TL-20591C-36-12T	M36X2	20	12	25	59.5	6	61	41
TL-20591C-42-16T	M42X2	25	16	30	78	9	73.5	50
TL-20591C-52-20T	M52X2	32	20	38	93	8	87.5	60

Note: 1. For use with braided hoses. 2. If use with spiral hoses, hose fitting series number is TL-20592C-xx-xx.

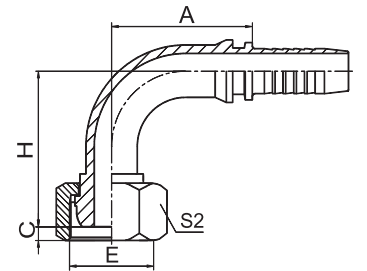

## TL-50011 · TL-50012

Metric. Standpipe Straight. DIN 2353

PART NO.	TUBE O.D.	HOSE BORE		DIMENSIONS	
		DN	DASH	A	C
TL-50011-06-03	6	5	03	31	22
TL-50011-06-04	6	6	04	31	22
TL-50011-10-05	10	8	05	32	23
TL-50011-10-06	10	10	06	32	23
TL-50011-12-06	12	10	06	33.5	23
TL-50011-12-08	12	12	08	33	23
TL-50011-15-06	15	10	06	35.5	25
TL-50011-15-08	15	12	08	36	25
TL-50011-18-08	18	12	08	36.5	26
TL-50011-18-10	18	16	10	41	26
TL-50011-22-10	22	16	10	44	28
TL-50011-22-12	22	20	12	44.5	28
TL-50011-22-16	22	25	16	46.2	28
TL-50011-28-16	28	25	16	46.7	30
TL-50011-35-20	35	32	20	56	36
TL-50011-42-24	42	40	24	62	40
TL-50011-08-04	8	6	04	33	24
TL-50011-08-05	8	8	05	33	24
TL-50011-08-06	8	10	06	33	24
TL-50011-10-04	10	6	04	35	26
TL-50011-12-04	12	6	04	36.5	26
TL-50011-12-05	12	8	05	36.5	26
TL-50011-14-06	14	10	06	39.5	29
TL-50011-14-08	14	12	08	40	29

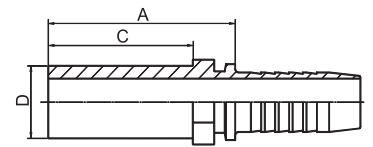

NEXT >

PART NO.	TUBE O.D.	HOSE BORE		DIMENSIONS	
		DN	DASH	A	C
TL-50011-14-12	14	20	12	46	29
TL-50011-16-08	16	12	08	41	30
TL-50011-16-10	16	16	10	45.5	30
TL-50011-20-10	20	16	10	52.5	36
TL-50011-20-12	20	20	12	52.5	36
TL-50011-25-12	25	20	12	57	40
TL-50011-25-16	25	25	16	58.7	40
TL-50011-30-16	30	25	16	62.7	44
TL-50011-30-20	30	32	20	64	44
TL-50011-38-16	38	25	16	69	50
TL-50011-38-20	38	32	20	70.5	50

Note: 1. For use with braided hoses. 2. If use with spiral hoses, hose fitting series number is TL-50012-xx-xx.

## TL-50041 · TL-50042

Metric. Elbow 45°. Straight. DIN 2353

PART NO.	TUBE O.D.	HOSE BORE	DIMENSIONS		
			DASH	A	C
TL-50041-06-03	6	5	48	22	27.5
TL-50041-06-04	6	6	44.5	22	30
TL-50041-08-05	8	8	55.7	24	32.4
TL-50041-08-06	8	10	57.9	24	33.1
TL-50041-10-05	10	8	54	23	30.6
TL-50041-10-06	10	10	52	23	31
TL-50041-12-06	12	10	58.5	23	34.5
TL-50041-12-08	12	12	72.4	23	37.4
TL-50041-15-06	15	10	51	25	34.5
TL-50041-15-08	15	12	70.5	25	36
TL-50041-18-08	18	12	64.5	26	38.5
TL-50041-18-10	18	16	74	26	40
TL-50041-22-10	22	16	87.1	28	42.3
TL-50041-22-12	22	20	81.5	28	46
TL-50041-22-16	22	25	100.9	28	46.7
TL-50041-28-16	28	25	94.7	30	50
TL-50041-35-20	35	32	107.5	36	58
TL-50041-08-04	8	6	43.5	24	31.5
TL-50041-10-04	10	6	53.5	26	32
TL-50041-12-04	12	6	57.1	26	35.1
TL-50041-12-05	12	8	59	26	36
TL-50041-14-06	14	10	53	29	37
TL-50041-14-08	14	12	74.5	29	39
TL-50041-14-12	14	20	91.9	29	43.8
TL-50041-16-08	16	12	76.6	30	41.7
TL-50041-16-10	16	16	87.8	30	43
TL-50041-20-10	20	16	76	36	48
TL-50041-20-12	20	20	100.7	36	52.6
TL-50041-25-12	25	20	84.5	40	54
TL-50041-25-16	25	25	109.4	40	55.2
TL-50041-30-16	30	25	96.7	44	60
TL-50041-30-20	30	32	124.2	44	63.5
TL-50041-38-16	38	25	117.9	50	63.6
TL-50041-38-20	38	32	111.5	50	68

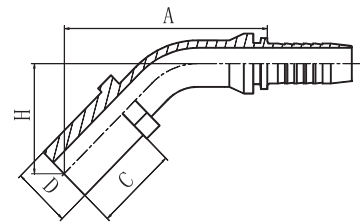

Note: 1. For use with braided hoses. 2. If use with spiral hoses, hose fitting series number is TL-50042-xx-xx.

# TL-50091 · TL-50092

Metric. Elbow 45°. Straight. DIN 2353

PART NO.	THREAD E	HOSE BORE		DIMENSIONS		
		DN	DASH	A	C	H
TL-50091-06-03	6	5	03	26.5	22	45
TL-50091-06-04	6	6	04	30.5	22	48
TL-50091-08-05	8	8	05	34	24	55.5
TL-50091-08-06	8	10	06	36	24	57.8
TL-50091-10-05	10	8	05	34	23	53
TL-50091-10-06	10	10	06	38	23	55
TL-50091-12-06	12	10	06	35	23	60
TL-50091-12-08	12	12	08	41	23	67
TL-50091-15-06	15	10	06	35	25	60
TL-50091-15-08	15	12	08	46.5	25	65
TL-50091-18-08	18	12	08	41	26	68.5
TL-50091-18-10	18	16	10	57	26	73
TL-50091-22-10	22	16	10	56.5	28	76.5
TL-50091-22-12	22	20	12	65.5	28	86
TL-50091-22-16	22	25	16	76.7	28	91.5
TL-50091-28-16	28	25	16	76.7	30	95.5
TL-50091-35-20	35	32	20	91.5	36	112.5
TL-50091-08-04	8	6	04	29.5	24	52.5
TL-50091-10-04	10	6	04	33.5	26	53
TL-50091-12-04	12	6	04	33.5	26	57.5
TL-50091-12-05	12	8	05	33	26	60.5
TL-50091-14-06	14	10	06	35	29	64
TL-50091-14-08	14	12	08	41	29	69
TL-50091-14-12	14	20	12	66.2	29	83
TL-50091-16-08	16	12	08	40.5	30	73
TL-50091-16-10	16	16	10	56.5	30	77.5
TL-50091-20-10	20	16	10	56.5	36	84.5
TL-50091-20-12	20	20	12	65.5	36	95.5
TL-50091-25-12	25	20	12	65.5	40	98
TL-50091-25-16	25	25	16	76.7	40	103.5
TL-50091-30-16	30	25	16	68.7	44	109.5
TL-50091-30-20	30	32	20	91.5	44	120.5
TL-50091-38-16	38	25	16	76.7	50	115.5
TL-50091-38-20	38	32	20	87.5	50	126.5

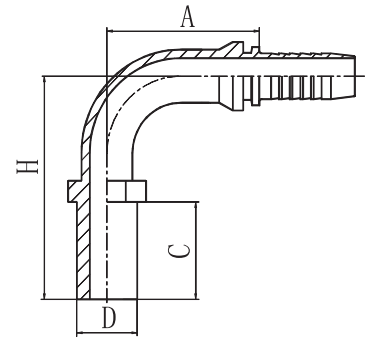

Note: 1. For use with braided hoses. 2. If use with spiral hoses, hose fitting series number is TL-50092-xx-xx.

# TL-13011-SP · TL-13012-SP

BSPT. Male

PART NO.	THREAD E	HOSE BORE		DIMENSIONS		
		DN	DASH	A	C	S1
TL-13011-02-04SP	R1/8"X28	6	04	22.5	10	12
TL-13011-04-04SP	R1/4"X19	6	04	27	14	14
TL-13011-06-06SP	R3/8"X19	10	06	28	15	17
TL-13011-08-08SP	R1/2"X14	12	08	35.5	20	22
TL-13011-10-10SP	R1/2"X14	20	12	36.5	20	24
TL-13011-12-12SP	R3/4"X14	20	12	38.5	20	27
TL-13011-16-16SP	R1"X11	25	16	46.3	25.5	36
TL-13011-20-20SP	R1.1/4"X11	32	20	49.5	26.5	46
TL-13011-24-24SP	R1.1/2"X11	40	24	51.5	26.5	50
TL-13011-32-32SP	R2"X11	50	32	57	30	65

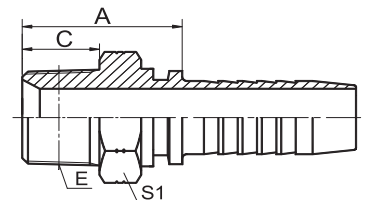

Note: 1. For use with braided hoses. 2. If use with spiral hoses, hose fitting series number is TL-13012-xx-xx.

## TL-12211 · TL-12212

BSP. Male. O-ring

PART NO.	THREAD E	HOSE BORE		O RING	DIMENSIONS		
		DN	DASH		A	C	S1
TL-12211-04-04	G1/4"X19	6	04	O111	25	11	19
TL-12211-06-06	G3/8"X19	10	06	O113	27	12	22
TL-12211-08-08	G1/2"X14	12	08	O115	30	14	27
TL-12211-10-10	G5/8"X14	16	10	O910	32	15.5	30
TL-12211-12-12	G3/4"X14	20	12	O119	33	16	32
TL-12211-16-16	G1"X11	25	16	O217	40.2	19	41
TL-12211-20-20	G1.1/4"X11	32	20	O222	45.5	20	50

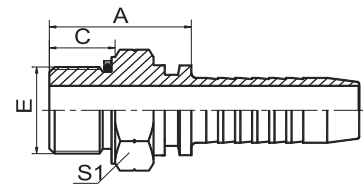

## TL-12611 · TL-12612

BSP. Male. 60°. Cone seat

PART NO.	THREAD E	HOSE BORE		DIMENSIONS		
		DN	DASH	A	C	S1
TL-12611-02-03	G1/8"X28	5	03	22.5	10	14
TL-12611-04-04	G1/4"X19	6	04	24.5	12	14
TL-12611-06-05	G3/8"X19	8	05	27	13.5	17
TL-12611-06-06	G3/8"X19	10	06	27.5	13.5	17
TL-12611-06-08	G3/8"X19	12	08	27.5	13.5	19
TL-12611-08-06	G1/2"X14	10	06	30.5	16	22
TL-12611-08-08	G1/2"X14	12	08	31	16	22
TL-12611-10-08	G5/8"X14	12	08	33	17.5	24
TL-12611-10-10	G5/8"X14	16	10	33.5	17.5	24
TL-12611-12-08	G3/4"X14	12	08	35.5	18.5	27
TL-12611-12-10	G3/4"X14	16	10	36	18.5	27
TL-12611-12-12	G3/4"X14	20	12	36.5	18.5	27
TL-12611-16-12	G1"X11	20	12	40	20.5	36
TL-12611-16-16	G1"X11	25	16	41.7	20.5	36
TL-12611-20-16	G1.1/4"X11	25	16	42.7	20.5	46
TL-12611-20-20	G1.1/4"X11	32	20	43.5	20.5	46
TL-12611-24-20	G1.1/2"X11	32	20	49	23	50
TL-12611-24-24	G1.1/2"X11	40	24	48.5	23	50
TL-12611-32-32	G2"X11	50	32	53.5	25.5	65

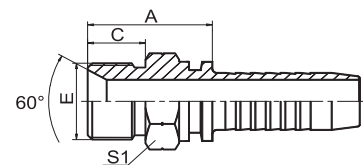

# TL-12611A · TL-12612A

BSP. Male. 60°. Cone seat or bonded seal

PART NO.	THREAD E	HOSE BORE		DIMENSIONS		
		DN	DASH	A	C	S1
TL-12611A-02-03	G1/8"X28	5	03	22.5	10	14
TL-12611A-04-04	G1/4"X19	6	04	24.5	12	19
TL-12611A-04-05	G1/4"X19	8	05	24.5	12	19
TL-12611A-06-05	G3/8"X19	8	05	26	13.5	22
TL-12611A-06-06	G3/8"X19	10	06	28	13.5	22
TL-12611A-06-08	G3/8"X19	12	08	28.5	13.5	22
TL-12611A-08-06	G1/2"X14	10	06	33	16	27
TL-12611A-08-08	G1/2"X14	12	08	33.5	16	27
TL-12611A-08-10	G1/2"X14	16	10	34	16	27
TL-12611A-10-08	G5/8"X14	12	08	35.5	17.5	30
TL-12611A-10-10	G5/8"X14	16	10	36	17.5	30
TL-12611A-12-08	G3/4"X14	12	08	37	18.5	32
TL-12611A-12-10	G3/4"X14	16	10	37.5	18.5	32
TL-12611A-12-12	G3/4"X14	20	12	38	18.5	32
TL-12611A-16-12	G1"X11	20	12	42	20.5	41
TL-12611A-16-16	G1"X11	25	16	43.7	20.5	41
TL-12611A-20-16	G1.1/4"X11	25	16	45.7	20.5	50
TL-12611A-20-20	G1.1/4"X11	32	20	49.5	20.5	50
TL-12611A-24-24	G1/2"X11	40	24	49	23	55
TL-12611A-32-32	G2"X11	50	32	54.5	25.5	70

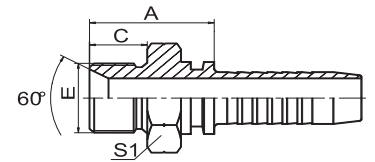

Note: 1. For use with braided hoses. 2. If use with spiral hoses, hose fitting series number is TL-12612A-xx-xx.

# TL-22111 · TL-22112

BSP. Female. Multiseal

PART NO.	THREAD E	HOSE BORE		DIMENSIONS		
		DN	DASH	A	C	S2
TL-22111-02-04	G1/8"X28	6	04	16.5	5.5	14
TL-22111-04-04	G1/4"X19	6	04	19.5	3.5	19
TL-22111-06-06	G3/8"X19	10	06	21.5	5.5	22
TL-22111-08-08	G1/2"X14	12	08	24	6.3	27
TL-22111-10-10	G5/8"X14	16	10	27	6	30
TL-22111-12-12	G3/4"X14	20	12	28	7	32
TL-22111-16-16	G1"X11	25	16	31.7	7	41
TL-22111-20-20	G1.1/4"X11	32	20	36.5	6.5	50
TL-22111-24-24	G1/2"X11	40	24	38	6.5	55
TL-22111-32-32	G2"X11	50	32	34	9	75

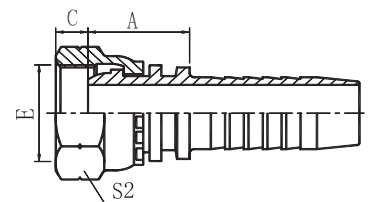

Note: 1. For use with braided hoses. 2. If use with spiral hoses, hose fitting series number is TL-22112-xx-xx.

# TL-22141 · TL-22142

BSP. Female. Elbow 45°. Multiseal

PART NO.	THREAD E	HOSE BORE		DIMENSIONS			
		DN	DASH	A	C	H	S2
TL-22141-02-04	G1/8"X28	6	04	43.7	5.5	21.6	14
TL-22141-04-04	G1/4"X19	6	04	40.5	3.5	21.6	19
TL-22141-06-06	G3/8"X19	10	06	48	5.5	24	22
TL-22141-08-08	G1/2"X14	12	08	61.5	6.3	27	27
TL-22141-10-10	G5/8"X14	16	10	70	6	29	30
TL-22141-12-12	G3/4"X14	20	12	76.5	7	33	32
TL-22141-16-16	G1"X11	25	16	91.7	7	35	41
TL-22141-20-20	G1.1/4"X11	32	20	105.5	6.5	41	50
TL-22141-24-24	G1.2"X11	40	24	113	6.5	49	55
TL-22141-32-32	G2"X11	50	32	150	9	53	70

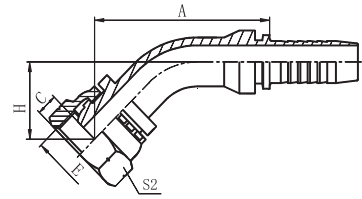

Note: 1. For use with braided hoses. 2. If use with spiral hoses, hose fitting series number is TL-22142-xx-xx.

# TL-22191 · TL-22192

BSP. Female. Elbow 90°. Multiseal

PART NO.	THREAD E	HOSE BORE		DIMENSIONS			
		DN	DASH	A	C	H	S2
TL-22191-02-04	G1/8"X28	6	04	32.5	5.5	35.5	14
TL-22191-04-04	G1/4"X19	6	04	32.5	3.5	38.5	19
TL-22191-06-06	G3/8"X19	10	06	36	5.5	45	22
TL-22191-08-08	G1/2"X14	12	08	48.5	6.3	52	27
TL-22191-10-10	G5/8"X14	16	10	54	6	57.5	30
TL-22191-12-12	G3/4"X14	20	12	56.5	7	68	32
TL-22191-16-16	G1"X11	25	16	76.7	7	75	41
TL-22191-20-20	G1.1/4"X11	32	20	92.5	6.5	89	50
TL-22191-24-24	G1.1/2"X11	40	24	110	6.5	108	55
TL-22191-32-32	G2"X11	50	32	135	9	124	70

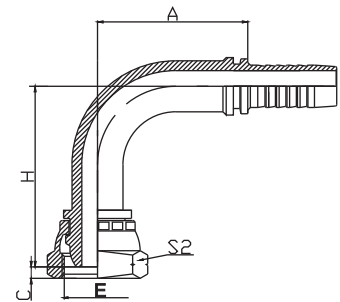

Note: 1. For use with braided hoses. 2. If use with spiral hoses, hose fitting series number is TL-22192-xx-xx.

# TL-22211 · TL-22212

BSP. Female. Flat seal

PART NO.	THREAD E	HOSE BORE		DIMENSIONS		
		DN	DASH	A	C	S1
TL-22211-04-04	G1/4"X19	6	04	15.5	7.5	19
TL-22211-06-06	G3/8"X19	10	06	17	9.5	22
TL-22211-08-08	G1/2"X14	12	08	19	11.5	27
TL-22211-10-10	G5/8"X14	16	10	20.5	12	30
TL-22211-12-12	G3/4"X14	20	12	21.5	13	32
TL-22211-16-16	G1"X11	25	16	25.7	14	41
TL-22211-20-20	G1.1/4"X11	32	20	27.5	15.5	50
TL-22211-24-24	G1.1/2"X11	40	24	27	17.5	55
TL-22211-32-32	G2"X11	50	32	30.5	24	70

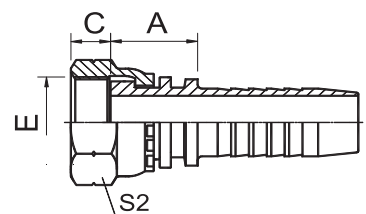

Note: 1. For use with braided hoses. 2. If use with spiral hoses, hose fitting series number is TL-22212-xx-xx.

## TL-22241 · TL-22242

BSP. Female. Elbow 45°. Flat seal

PART NO.	THREAD E	HOSE BORE		DIMENSIONS			
		DN	DASH	A	C	H	S2
TL-22241-04-04	G1/4"X19	6	04	37.5	7.5	19	19
TL-22241-06-06	G3/8"X19	10	06	46	9.5	21	22
TL-22241-08-08	G1/2"X14	12	08	58.5	11.5	24	27
TL-22241-12-12	G3/4"X14	20	12	72.5	13	30	32
TL-22241-16-16	G1"X11	25	16	87.7	14	31.5	41
TL-22241-20-20	G1.1/4"X11	32	20	100.5	15.5	36	50

Note: 1. For use with braided hoses. 2. If use with spiral hoses, hose fitting series number is TL-22242-xx-xx.

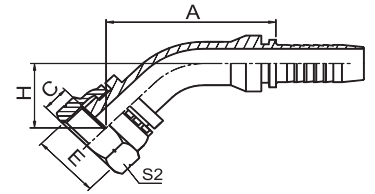

## TL-22291 · TL-22292

BSP. Female. Elbow 90°. Flat seal

PART NO.	THREAD E	HOSE BORE		DIMENSIONS			
		DN	DASH	A	C	H	S2
TL-22291-04-04	G1/4"X19	6	04	30	7.5	34.5	19
TL-22291-06-06	G3/8"X19	10	06	35	9.5	41	22
TL-22291-08-08	G1/2"X14	12	08	41	11.5	48	27
TL-22291-12-12	G3/4"X14	20	12	65.5	13	63.5	32
TL-22291-16-16	G1"X11	25	16	69.7	14	70	41
TL-22291-20-20	G1.1/4"X11	32	20	88.5	15.5	82.5	50
TL-22291-24-24	G1.1/2"X11	40	24	109.5	17.5	97.5	55

Note: 1. For use with braided hoses. 2. If use with spiral hoses, hose fitting series number is TL-22292-xx-xx.

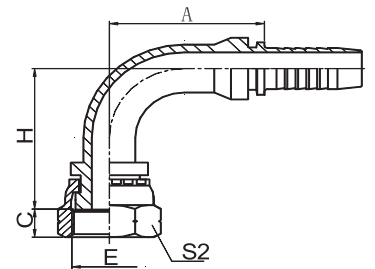

## TL-22611 · TL-22612

BSP. Female. 60° Cone seat

PART NO.	THREAD E	HOSE BORE		DIMENSIONS			
		DN	DASH	A	C	S2	
TL-22611-02-03	G1/8"X28	5	03	16	6	14	
TL-22611-02-04	G1/8"X28	6	04	16	6	14	
TL-22611-04-03	G1/4"X19	5	03	18.5	5	19	
TL-22611-04-04	G1/4"X19	6	04	18.5	5	19	
TL-22611-04-05	G1/4"X19	8	05	18.5	5	19	
TL-22611-04-06	G1/4"X19	10	06	18.5	5	19	
TL-22611-06-04	G3/8"X19	6	04	20.5	6.5	22	

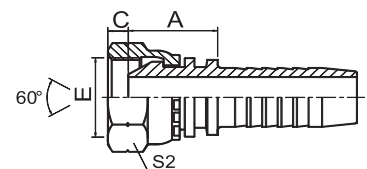

NEXT >



PART NO.	THREAD E	HOSE BORE		DIMENSIONS		
		DN	DASH	A	C	S2
TL-22611-06-05	G3/8"X19	8	05	20.5	6.5	22
TL-22611-06-06	G3/8"X19	10	06	20.5	6.5	22
TL-22611-06-08	G3/8"X19	12	08	21	6.5	22
TL-22611-08-06	G1/2"X14	10	06	22	7.8	27
TL-22611-08-08	G1/2"X14	12	08	22.5	7.8	27
TL-22611-10-08	G5/8"X14	12	08	23.5	9	30
TL-22611-10-10	G5/8"X14	16	10	24	9	30
TL-22611-12-08	G3/4"X14	12	08	22	10.5	32
TL-22611-12-10	G3/4"X14	16	10	23.5	10.5	32
TL-22611-12-12	G3/4"X14	20	12	24	10.5	32
TL-22611-16-12	G1"X11	20	12	25	11	41
TL-22611-16-14	G1"X11	22	14	26	11	41
TL-22611-16-16	G1"X11	25	16	27.7	11	41
TL-22611-20-16T	G1.1/4"X11	25	16	27.7	11	50
TL-22611-20-20	G1.1/4"X11	32	20	31	11.5	50
TL-22611-24-20	G1.1/2"X11	32	20	32	12.5	55
TL-22611-24-24	G1.1/2"X11	40	24	32	12.5	55
TL-22611-32-24	G2"X11	40	24	37	16	70
TL-22611-32-32	G2"X11	50	32	31.9	16	70

Note: 1. For use with braided hoses. 2. If use with spiral hoses, hose fitting series number is TL-22612-xx-xx.

## TL-22641 · TL-22642

BSP. Female. Elbow 45°. 60° Cone seat

PART NO.	THREAD E	HOSE BORE		DIMENSIONS			
		DN	DASH	A	C	H	S2
TL-22641-04-04	G1/4"X19	6	04	42.5	5	20	19
TL-22641-06-04	G3/8"X19	6	04	42.5	6.5	20	22
TL-22641-06-05	G3/8"X19	8	05	45	6.5	22	22
TL-22641-06-06	G3/8"X19	10	06	47	6.5	22.5	22
TL-22641-08-06	G1/2"X14	10	06	48	7.8	24	27
TL-22641-08-08	G1/2"X14	12	08	61	7.8	26	27
TL-22641-10-08	G5/8"X14	12	08	61.5	9	26.5	30
TL-22641-10-10	G5/8"X14	16	10	72.5	9	28	30
TL-22641-12-08	G3/4"X14	12	08	61.5	10.5	27	32
TL-22641-12-10	G3/4"X14	16	10	73	10.5	28	32
TL-22641-12-12	G3/4"X14	20	12	79.5	10.5	32	32
TL-22641-16-12	G1"X11	20	12	80.5	11	33.5	41
TL-22641-16-16	G1"X11	25	16	88.7	11	34	41
TL-22641-20-16	G1.1/4"X11	25	16	89.7	11.5	36	50
TL-22641-20-20	G1.1/4"X11	32	20	100.5	11.5	40	50
TL-22641-24-24	G1/2"X11	40	24	116	12.5	45	55
TL-22641-32-32	G2"X11	50	32	135.7	16	52.7	70

Note: 1. For use with braided hoses. 2. If use with spiral hoses, hose fitting series number is TL-22642-xx-xx.

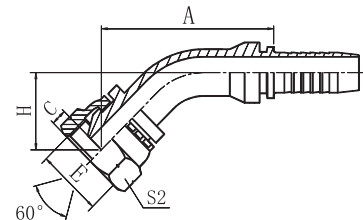

# TL-22691 · TL-22692

BSP. Female. Elbow 90°. 60° Cone seat

PART NO.	THREAD E	HOSE BORE		DIMENSIONS			
		DN	DASH	A	C	H	S2
TL-22691-02-03	G1/8"X28	5	03	26.5	6	31.5	14
TL-22691-02-04	G1/8"X28	6	04	30	6	34.5	14
TL-22691-04-03	G1/4"X19	5	03	26.5	5	33.5	19
TL-22691-04-04	G1/4"X19	6	04	30	5	36.5	19
TL-22691-04-05	G1/4"X19	8	05	33	5	41	19
TL-22691-04-06	G1/4"X19	10	06	35	5	43	19
TL-22691-06-04	G3/8"X19	6	04	30	6.5	38	22
TL-22691-06-05	G3/8"X19	8	05	33.5	6.5	41	22
TL-22691-06-06	G3/8"X19	10	06	35	6.5	43	22
TL-22691-08-06	G1/2"X14	10	06	35	7.8	46	27
TL-22691-08-08	G1/2"X14	12	08	41	7.8	51	27
TL-22691-08-10	G1/2"X14	16	10	56.5	7.8	55	27
TL-22691-10-08	G5/8"X14	12	08	41	9	51.5	30
TL-22691-10-10	G5/8"X14	16	10	56.5	9	56	30
TL-22691-12-08	G3/4"X14	12	08	41	10.5	52	32
TL-22691-12-10	G3/4"X14	16	10	56.5	10.5	56.5	32
TL-22691-12-12	G3/4"X14	20	12	65.5	10.5	66	32
TL-22691-16-12	G1"X11	20	12	65	11	68	41
TL-22691-16-14	G1"X11	22	14	71.2	11	69.3	41
TL-22691-16-16	G1"X11	25	16	76.7	11	74	41
TL-22691-20-16	G1.1/4"X11	25	16	76.7	11.5	76	50
TL-22691-20-20	G1.1/4"X11	32	20	91.5	11.5	87	50
TL-22691-24-24	G1.1/2"X11	40	24	110	12.5	102	55
TL-22691-32-32	G2"X11	50	32	131.8	16	123.3	70

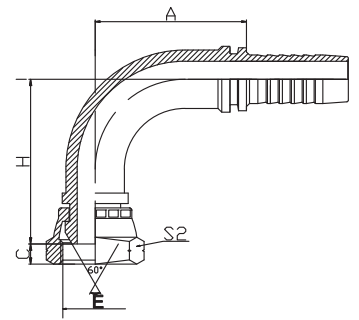

Note: 1. For use with braided hoses. 2. If use with spiral hoses, hose fitting series number is TL-22692-xx-xx.

# TL-22611D · TL-22612D

BSP. Female. 60° Cone seat. Double hex

PART NO.	THREAD E	HOSE BORE		DIMENSIONS			
		DN	DASH	A	C	S1	S2
TL-22611D-04-04	G1/4"X19	6	04	25.5	5	19	19
TL-22611D-06-06	G3/8"X19	10	06	27.5	6.5	22	22
TL-22611D-08-08	G1/2"X14	12	08	29.5	7.8	27	27
TL-22611D-10-08	G5/8"X14	12	08	32	9	30	30
TL-22611D-12-08	G3/4"X14	12	08	33	10.5	32	32
TL-22611D-12-12	G3/4"X14	20	12	31.5	10.5	32	32
TL-22611D-16-16	G1"X11	25	16	37.7	11	41	41
TL-22611D-20-20	G1.1/4"X11	32	20	44	11.5	50	50

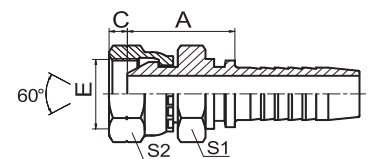

Note: 1. For use with braided hoses. 2. If use with spiral hoses, hose fitting series number is TL-22612D-xx-xx.

# TL-22611D-SM · TL-22612D-SM

BSP. Female. 60° Cone seat. Double hex

PART NO.	THREAD E	HOSE BORE		DIMENSIONS			
		DN	DASH	A	C	S1	S2
TL-22611D-04-04SM	G1/4"X19	6	04	23.5	5	14	19
TL-22611D-06-06SM	G3/8"X19	10	06	26	6.5	17	22
TL-22611D-08-08SM	G1/2"X14	12	08	28.5	7.8	22	27
TL-22611D-10-08SM	G5/8"X14	12	08	30	9	22	30
TL-22611D-12-08SM	G3/4"X14	12	08	32.1	10.5	27	32
TL-22611D-12-12SM	G3/4"X14	20	12	32.5	10.5	27	32
TL-22611D-16-16SM	G1"X11	25	16	36.3	11	32	41
TL-22611D-20-20SM	G1.1/4"X11	32	20	41.5	11.5	41	50

Note: 1. For use with braided hoses. 2. If use with spiral hoses, hose fitting series number is TL-22612D-xx-xxSM.

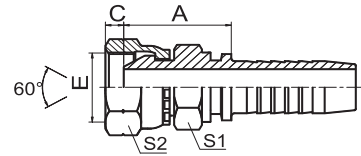

# TL-22691K · TL-22692K

BSP. Female. Elbow 90°. 60° Cone seat. Double hex

PART NO.	THREAD E	HOSE BORE		DIMENSIONS				
		DN	DASH	A	C	H	S1	S2
TL-22691K-04-04	G1/4"X19	6	04	17.5	5	18.5	11	19
TL-22691K-06-04	G3/8"X19	6	04	20	6.5	24	16	22
TL-22691K-06-05	G3/8"X19	8	05	20	6.5	24	16	22
TL-22691K-06-06	G3/8"X19	10	06	20	6.5	24	16	22
TL-22691K-08-06	G1/2"X14	10	06	23	7.8	26.5	19	27
TL-22691K-08-08	G1/2"X14	12	08	23.5	7.8	28.5	19	27
TL-22691K-10-10	G5/8"X14	16	10	25	9	29.2	22	30
TL-22691K-12-12	G3/4"X14	20	12	27.5	10.5	33	27	32
TL-22691K-16-16	G1"X11	25	16	32.7	11	38.1	33	41

Note: 1. For use with braided hoses. 2. If use with spiral hoses, hose fitting series number is TL-22692K-xx-xx.

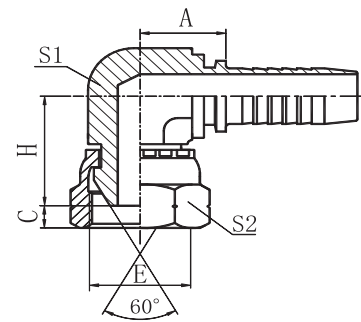

# TL-16011 · TL-16012

SAE. Male. O-ring. ISO 11926 - SAE J2926

PART NO.	THREAD E	HOSE BORE		O-RING	DIMENSIONS		
		DN	DASH		A	C	S1
TL-16011-04-04	7/16"X20	6	04	O904	21.5	9	14
TL-16011-05-04	1/2"X20	6	04	O905	21.5	9	17
TL-16011-06-05	9/16"X18	8	05	O906	22.5	9.9	17
TL-16011-06-06	9/16"X18	10	06	O906	22.5	10	17
TL-16011-08-06	3/4"X16	10	06	O908	24.5	11	22
TL-16011-08-08	3/4"X16	12	08	O908	25	11	22
TL-16011-10-08	7/8"X14	12	08	O910	29.5	13	27
TL-16011-10-10	7/8"X14	16	10	O910	30	13	27
TL-16011-12-10	1.1/16"X12	16	10	O912	31.5	15	32
TL-16011-12-12	1.1/16"X12	20	12	O912	32	15	32
TL-16011-16-16	1.5/16"X12	25	16	O916	36.2	15.1	38

Note: 1. For use with braided hoses. 2. If use with spiral hoses, hose fitting series number is TL-16012-xx-xx.

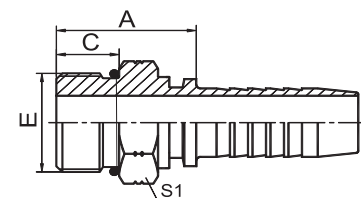

# TL-15611 · TL-15612

NPT. Male. 60° Cone seat

ISO 8432-2 - SAE J514

PART NO.	THREAD E	HOSE BORE		DIMENSIONS		
		DN	DASH	A	C	S1
TL-15611-02-03	Z1/8"X27	5	03	22.5	10	12
TL-15611-02-04	Z1/8"X27	6	04	21.5	10	12
TL-15611-04-03	Z1/4"X18	5	03	28.5	15	17
TL-15611-04-04	Z1/4"X18	6	04	28	15	17
TL-15611-04-05	Z1/4"X18	8	05	28	15	17
TL-15611-04-06	Z1/4"X18	10	06	28	15	17
TL-15611-06-04	Z3/8"X18	6	04	29.5	16	19
TL-15611-06-05	Z8"X18	8	05	29.5	16	19
TL-15611-06-06	Z3/8"X18	10	06	30	16	19
TL-15611-06-08	Z3/8"X18	12	08	30.5	16	22
TL-15611-08-06	Z1/2"X14	10	06	34	19.5	22
TL-15611-08-08	Z1/2"X14	12	08	34.5	19.5	22
TL-15611-08-10	Z1/2"X14	16	10	36	19.5	24
TL-15611-12-08	Z3/4"X14	12	08	37.5	19.5	27
TL-15611-12-10	Z3/4"X14	16	10	38	19.5	27
TL-15611-12-12	Z3/4"X14	20	12	38.5	19.5	27
TL-15611-12-16	Z3/4"X14	25	16	40.7	19.5	32
TL-15611-16-10	Z1"X11.5	16	10	44.5	25.5	36
TL-15611-16-12	Z1"X11.5	20	12	45	25.5	36
TL-15611-16-16	Z1"X11.5	25	16	46.7	25.5	36
TL-15611-20-16	Z1.1/4"X11.5	25	16	48.7	26.5	46
TL-15611-20-20	Z1.1/4"X11.5	32	20	49.5	26.5	46
TL-15611-24-24	Z1.1/2"X11.5	40	24	51	27.5	50
TL-15611-32-32	Z2"X11.5	50	32	55	27.5	65

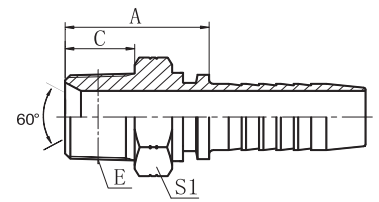

Note: 1. For use with braided hoses. 2. If use with spiral hoses, hose fitting series number is TL-15612-xx-xx.

# TL-16711 · TL-16712

JIC. Male. 74° Cone seat

ISO 8432-2 - SAE J514

PART NO.	THREAD E	HOSE BORE		DIMENSIONS		
		DN	DASH	A	C	S1
TL-16711-04-03	7/16"X20	5	03	26.5	14	12
TL-16711-04-04	7/16"X20	6	04	26.5	14	12
TL-16711-05-04	1/2"X20	6	04	26.5	14	14
TL-16711-05-05	1/2"X20	8	05	26.5	14	14
TL-16711-05-06	1/2"X20	10	06	26.5	14	17
TL-16711-06-04	9/16"X18	6	04	26.5	14	17
TL-16711-06-05	9/16"X18	8	05	26.5	14	17
TL-16711-06-06	9/16"X18	10	06	26.5	14	17
TL-16711-08-06	3/4"X16	10	06	31.5	16.7	22
TL-16711-08-08	3/4"X16	12	08	32	16.7	22
TL-16711-10-06	7/8"X14	10	06	34.5	19.5	24
TL-16711-10-08	7/8"X14	12	08	35	19.5	24
TL-16711-10-10	7/8"X14	16	10	35.5	19.5	24
TL-16711-12-08	1.1/16"X12	12	08	39	22	27
TL-16711-12-10	1.1/16"X12	16	10	39.5	22	27
TL-16711-12-12	1.1/16"X12	20	12	40	22	27
TL-16711-12-16	1.1/16"X12	25	16	42.7	22	36
TL-16711-14-10	1.3/16"X12	16	10	41.5	22.6	32
TL-16711-14-12	1.3/16"X12	20	12	40.5	22.5	32
TL-16711-16-12	1.5/16"X12	20	12	42.5	23	36
TL-16711-16-16	1.5/16"X12	25	16	44.2	23	36
TL-16711-20-16	1.5/8"X12	25	16	46.7	24.5	46
TL-16711-20-20	1.5/8"X12	32	20	47.5	24.5	46
TL-16711-24-20	1.7/8"X12	32	20	53.5	27.5	50
TL-16711-24-24	1.7/8"X12	40	24	53	27.5	50
TL-16712-32-32	2.1/2"X12	50	32	62	33.9	65

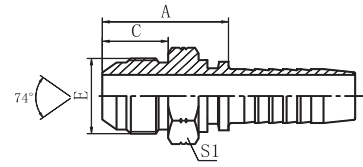

Note: 1. For use with braided hoses. 2. If use with spiral hoses, hose fitting series number is TL-16712-xx-xx.

# TL-26711 · TL-26712

JIC. Female. 74° Cone seat

SAE J514

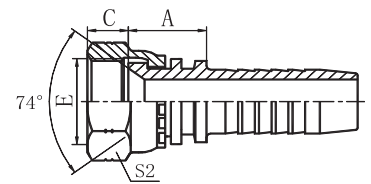

PART NO.	THREAD E	HOSE BORE		DIMENSIONS		
		DN	DASH	A	C	S2
TL-26711-04-03	7/16"X20	5	03	15	8	17
TL-26711-04-04	7/16"X20	6	04	15.5	8	17
TL-26711-05-04	1/2"X20	6	04	16.5	9	19
TL-26711-05-05	1/2"X20	8	05	16.5	9	19
TL-26711-05-06	1/2"X20	10	06	16.5	9	19
TL-26711-06-04	9/16"X18	6	04	17	9.5	19
TL-26711-06-05	9/16"X18	8	05	17	9.5	19
TL-26711-06-06	9/16"X18	10	06	17	9.5	19
TL-26711-06-08	9/16"X18	12	08	17.5	9.5	19
TL-26711-08-06	3/4"X16	10	06	18	10.8	24
TL-26711-08-08	3/4"X16	12	08	18.5	10.8	24
TL-26711-08-10	3/4"X16	16	10	19.5	10.8	24
TL-26711-10-08	7/8"X14	12	08	20	12	27
TL-26711-10-10	7/8"X14	16	10	20.5	12	27
TL-26711-10-12	7/8"X14	20	12	21	12	27
TL-26711-12-08	1.1/16"X12	12	08	20.5	15	32
TL-26711-12-10	1.1/16"X12	16	10	21	15	32
TL-26711-12-12	1.1/16"X12	20	12	21.5	15	32
TL-26711-12-16	1.1/16"X12	25	16	23.2	15	32
TL-26711-14-12	1.3/16"X12	20	12	22	15	36
TL-26711-16-12	1.5/16"X12	20	12	23	14	41
TL-26711-16-16	1.5/16"X12	25	16	24.7	14	41
TL-26711-16-20	1.5/16"X12	32	20	25.5	14	41
TL-26711-20-16	1.5/8"X12	25	16	26.7	15	50
TL-26711-20-20	1.5/8"X12	32	20	27.5	15	50
TL-26711-24-20	1.7/8"X12	32	20	21.5	19	55
TL-26711-24-24	1.7/8"X12	40	24	27	19	55
TL-26711-32-24	2.1/2"X12	40	24	29	23.5	75
TL-26711-32-32	2.1/2"X12	50	32	27	23.5	75

Note: 1. For use with braided hoses. 2. If use with spiral hoses, hose fitting series number is TL-26712-xx-xx.

# TL-26741 · TL-26742

JIC. Female. 74° Cone seat

SAE J514

PART NO.	THREAD E	HOSE BORE		DIMENSIONS			
		DN	DASH	A	C	H	S2
TL-26741-04-03	7/16"X20	5	03	39.5	8	18	17
TL-26741-04-04	7/16"X20	6	04	40	8	18.1	17
TL-26741-05-04	1/2"X20	6	04	40.5	9	18.5	19
TL-26741-05-05	1/2"X20	8	05	43	9	19	19
TL-26741-05-06	1/2"X20	10	06	43.5	9	19.5	19
TL-26741-06-04	9/16"X18	6	04	40.5	9.5	18.5	19
TL-26741-06-05	9/16"X18	8	05	43	9.5	19	19
TL-26741-06-06	9/16"X18	10	06	44	9.5	20	19
TL-26741-06-08	9/16"X18	12	08	58.5	9.5	23.5	19
TL-26741-08-06	3/4"X16	10	06	46	10.8	21.5	24
TL-26741-08-08	3/4"X16	12	08	58.5	10.8	23.5	24
TL-26741-10-08	7/8"X14	12	08	58.6	12	24	27
TL-26741-10-10	7/8"X14	16	10	70	12	25	27
TL-26741-10-12	7/8"X14	20	12	78	12	30	27
TL-26741-12-08	1.1/16"X12	12	08	60	15	25	32
TL-26741-12-10	1.1/16"X12	16	10	71	15	26.5	32
TL-26741-12-12	1.1/16"X12	20	12	78	15	30	32
TL-26741-12-16	1.1/16"X12	25	16	85.7	15	31	32
TL-26741-14-12	1.3/16"X12	20	12	77.5	15	30	36
TL-26741-16-12	1.5/16"X12	20	12	77.5	14	30	41
TL-26741-16-16	1.5/16"X12	25	16	85.7	14	31.5	41
TL-26741-16-20	1.5/16"X12	32	20	97.5	14	36.5	41
TL-26741-20-20	1.5/8"X12	32	20	97.5	15	36.5	50
TL-26741-24-20	1.7/8"X12	32	20	97.5	19	40	55
TL-26741-24-24	1.7/8"X12	40	24	111	19	41.5	55
TL-26741-32-32	2.1/2"X12	50	32	135.9	23.5	51.6	75

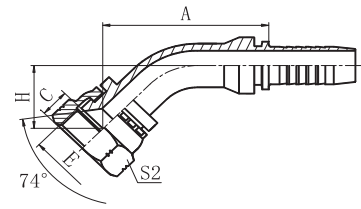

Note: 1. For use with braided hoses. 2. If use with spiral hoses, hose fitting series number is TL-2674S2-xx-xx.

# TL-26791 · TL-26792

JIC. Female. Elbow 90°. 74° Cone seat. SAE J514

PART NO.	THREAD E	HOSE BORE		DIMENSIONS			
		DN	DASH	A	C	H	S2
TL-26791-04-03	7/16"X20	5	03	26.5	8	30.5	17
TL-26791-04-04	7/16"X20	6	04	30	8	33.5	17
TL-26791-05-04	1/2"X20	6	04	30	9	34	17
TL-26791-05-05	1/2"X20	8	05	34	9	37	19
TL-26791-05-06	1/2"X20	10	06	36	9	37	19
TL-26791-06-04	9/16"X18	6	04	30	9.5	34	19
TL-26791-06-05	9/16"X18	8	05	34	9.5	38	19
TL-26791-06-06	9/16"X18	10	06	36	9.5	39	19
TL-26791-06-08	9/16"X18	12	08	41.5	9.5	46	19
TL-26791-08-06	3/4"X16	10	06	36	10.8	41	24
TL-26791-08-08	3/4"X16	12	08	41.5	10.8	47	24
TL-26791-08-10	3/4"X16	16	10	57	10.8	51.5	24
TL-26791-10-08	7/8"X14	12	08	41.5	12	48	27
TL-26791-10-10	7/8"X14	16	10	57	12	52.5	27
TL-26791-10-12	7/8"X14	20	12	65.5	12	63	27
TL-26791-12-08	1.1/16"X12	12	08	41.5	15	50	32
TL-26791-12-10	1.1/16"X12	16	10	57	15	54	32
TL-26791-12-12	1.1/16"X12	20	12	65.5	15	63.5	32
TL-26791-12-16	1.1/16"X12	25	16	76.7	15	70	32
TL-26791-14-12	1.3/16"X12	20	12	65	15	63.5	36
TL-26791-16-12	1.5/16"X12	20	12	65.5	14	63.5	41
TL-26791-16-16	1.5/16"X12	25	16	76.7	14	70	41
TL-26791-16-20	1.5/16"X12	32	20	91.5	14	81	41
TL-26791-20-20	1.5/8"X12	32	20	91.5	15	82.5	50
TL-26791-24-20	1.7/8"X12	32	20	91.5	19	83	55
TL-26791-24-24	1.7/8"X12	40	24	109.5	19	97.5	55
TL-26791-32-32	2.1/2"X12	50	32	134	23.5	123	75

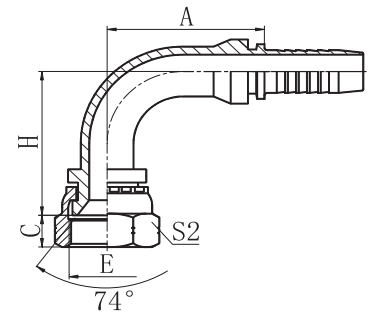

Note: 1. For use with braided hoses. 2. If use with spiral hoses, hose fitting series number is TL-26792-xx-xx.

# TL-26711D · TL-26711D

JIC. Female. 74° Cone seat. Double hex. SAE J514

PART NO.	THREAD E	HOSE BORE		DIMENSIONS			
		DN	DASH	A	C	S1	S2
TL-26711D-04-04	7/16"X20	6	04	21.5	8	14	17
TL-26711D-05-04	1/2"X20	6	04	22	9	17	19
TL-26711D-06-04	9/16"X18	6	04	24	9.5	19	19
TL-26711D-06-06	9/16"X18	10	06	24	9.5	19	19
TL-26711D-08-06	3/4"X16	10	06	25	10.8	24	24
TL-26711D-08-08	3/4"X16	12	08	25.5	10.8	24	24
TL-26711D-08-10	3/4"X16	16	10	25.5	10.8	24	24
TL-26711D-10-08	7/8"X14	12	08	28	12	27	27
TL-26711D-10-10	7/8"X14	16	10	28.5	12	27	27
TL-26711D-12-12	1.1/16"X12	20	12	29	15	32	32
TL-26711D-16-12	1.5/16"X12	20	12	32	14	41	41
TL-26711D-16-16	1.5/16"X12	25	16	34.7	14	41	41
TL-26711D-16-20	1.5/16"X12	32	20	36.5	14	41	41
TL-26711D-20-20	1.5/8"X12	32	20	40	15	50	50

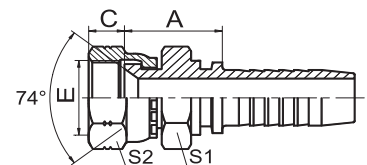

Note: 1. For use with braided hoses. 2. If use with spiral hoses, hose fitting series number is TL-26712D-xx-xx.



# TL-26711D-SM · TL-26712D-SM

JIC. Female. 74° Cone seat. Double hex. SAE J514

PART NO.	THREAD E	HOSE BORE		DIMENSIONS			
		DN	DASH	A	C	S1	S2
TL-26711D-04-04SM	7/16"X20	6	04	21.5	8	12	17
TL-26711D-05-04SM	1/2"X20	6	04	20.5	9	12	17
TL-26711D-06-04SM	9/16"X18	6	04	21	9.5	14	19
TL-26711D-06-06SM	9/16"X18	10	06	23	9.5	17	19
TL-26711D-08-06SM	3/4"X16	10	06	23	10.8	19	24
TL-26711D-08-08SM	3/4"X16	12	08	24.5	10.8	22	24
TL-26711D-08-10SM	3/4"X16	16	10	25.5	10.8	22	24
TL-26711D-10-08SM	7/8"X14	12	08	24	12	22	27
TL-26711D-10-10SM	7/8"X14	16	10	27	12	22	27
TL-26711D-12-12SM	1.1/16"X12	20	12	31.5	15	27	32
TL-26711D-16-12SM	1.5/16"X12	20	12	31.5	14	32	41
TL-26711D-16-16SM	1.5/16"X12	25	16	32.5	14	32	41
TL-26711D-20-20SM	1.5/8"X12	32	20	36.5	15	41	50

Note: 1. For use with braided hoses. 2. If use with spiral hoses, hose fitting series number is TL-26712D-xx-xxSM.

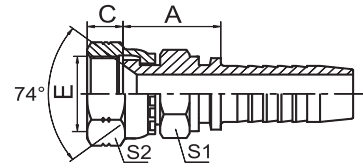

# TL-26791K · TL-26792K

JIC. Compact female. Elbow 90°. 74° Cone seat. SAE J514

PART NO.	THREAD E	HOSE BORE		DIMENSIONS				
		DN	DASH	A	C	H	S1	S2
TL-26791K-04-04	7/16"X20	6	04	17.5	8	18	11	15
TL-26791K-06-04	9/16"X18	6	04	19	9.5	21	14	19
TL-26791K-06-06	9/16"X18	10	06	20	9.5	21	16	19
TL-26791K-08-06	3/4"X16	10	06	23	10.8	25	19	24
TL-26791K-08-08	3/4"X16	12	08	23.5	10.8	25	19	24
TL-26791K-10-08	7/8"X14	12	08	23.5	12	27.5	22	27
TL-26791K-10-10	7/8"X14	16	10	25	12	27.5	22	27
TL-26791K-12-12	1.1/16"X12	20	12	27.5	15	30	27	32
TL-26791K-16-16	1.5/16"X12	25	16	42.7	14	34.3	33	41

Note: 1. For use with braided hoses. 2. If use with spiral hoses, hose fitting series number is TL-26792K-xx-xx.

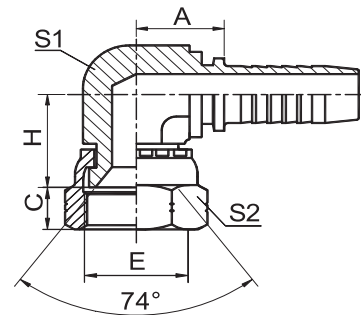

# TL-17811 · TL-17812

SAE. Male. 90° Cone seat. SAE J514

PART NO.	THREAD E	HOSE BORE		DIMENSIONS		
		DN	DASH	A	C	S1
TL-17811-04-04	7/16"X20	6	04	25.5	12.7	12
TL-17811-05-05	1/2"X20	8	05	27	14.2	14
TL-17811-06-06	5/8"X18	10	06	28.5	15.7	17
TL-17811-08-08	3/4"X16	12	08	34	19	22
TL-17811-10-10	7/8"X14	16	10	38.5	22.4	24
TL-17811-12-12	1.1/16"X14	20	12	43.5	25.4	30

Note: 1. For use with braided hoses. 2. If use with spiral hoses, hose fitting series number is TL-17812-xx-xx.

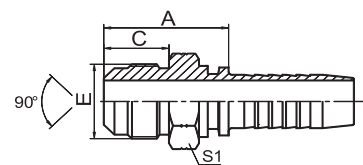

# TL-27811 · TL-27812

SAE. Female. 90° Cone seat. SAE J513

PART NO.	THREAD E	HOSE BORE		DIMENSIONS		
		DN	DASH	A	C	S2
TL-27811-04-04	7/16"X20	5	03	15.5	8	17
TL-27811-04-05	7/16"X20	6	04	15	8	15
TL-27811-05-05	1/2"X20	8	05	15.5	9.5	17
TL-27811-06-04	5/8"X18	6	04	17.5	11	22
TL-27811-06-05	5/8"X18	8	05	17.5	11	22
TL-27811-06-06	5/8"X18	10	06	17.5	11	22
TL-27811-08-08	3/4"X16	12	08	18.5	10.8	24
TL-27811-10-08	7/8"X14	12	08	18.5	12	27
TL-27811-10-10	7/8"X14	16	10	20	12	27
TL-27811-12-12	1.1/16"X14	20	12	21.5	13	32

Note: 1. For use with braided hoses. 2. If use with spiral hoses, hose fitting series number is TL-27812-xx-xx.

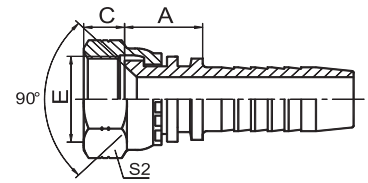

# TL-27841 · TL-27842

SAE. Female. Elbow 45°. 90° Cone seat. SAE J513

PART NO.	THREAD E	HOSE BORE		DIMENSIONS			
		DN	DASH	A	C	H	S2
TL-27841-04-03	7/16"X20	5	03	37.6	8	17.2	15
TL-27841-06-04	5/8"X18	6	04	42	11	20	22
TL-27841-06-05	5/8"X18	8	05	44.1	11	20.7	22
TL-27841-06-06	5/8"X18	10	06	46	11	21.5	22
TL-27841-08-08	3/4"X16	12	08	58.2	10.8	23.3	24
TL-27841-10-08	7/8"X14	12	08	58.2	12	23.3	27
TL-27841-10-10	7/8"X14	16	10	69.4	12	24.6	27
TL-27841-12-12	1.1/16"X14	20	12	77.4	13	30	32

Note: 1. For use with braided hoses. 2. If use with spiral hoses, hose fitting series number is TL-27842-xx-xx.

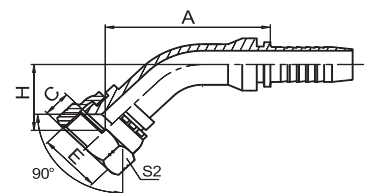

# TL-27891 · TL-27892

SAE. Female. Elbow 90°. 90° Cone seat. SAE J513

PART NO.	THREAD E	HOSE BORE		DIMENSIONS			
		DN	DASH	A	C	H	S2
TL-27891-04-03	7/16"X20	5	03	26.5	8	30.5	15
TL-27891-06-04	5/8"X18	6	04	32.5	11	36	22
TL-27891-06-05	5/8"X18	8	05	35	11	41.5	22
TL-27891-06-06	5/8"X18	10	06	35	11	41.5	22
TL-27891-10-08	7/8"X14	12	08	41	12	47	27
TL-27891-10-10	7/8"X14	16	10	56.5	12	51.5	27
TL-27891-12-12	1.1/16"X14	20	12	65.5	13	63.5	32

Note: 1. For use with braided hoses. 2. If use with spiral hoses, hose fitting series number is TL-27892-xx-xx.

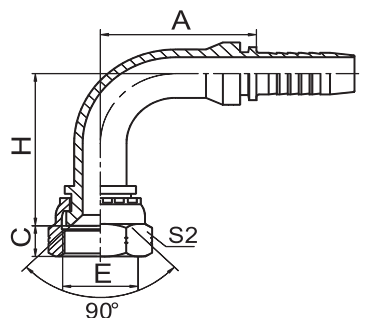

# TL-14211 · TL-14212

ORFS. Male. O-ring. ISO 8434-3 - SAE J1453

PART NO.	THREAD E	HOSE BORE		O-RING	DIMENSIONS		
		DN	DASH		A	C	S1
TL-14211-04-04	9/16"X18	6	04	O011	23.5	10	17
TL-14211-06-04	11/16"X16	6	04	O012	25	11	19
TL-14211-06-06	11/16"X16	10	06	O012	25	11	19
TL-14211-08-06	13/16"X16	10	06	O014	28	13	22
TL-14211-08-08	13/16"X16	12	08	O014	28.5	13	22
TL-14211-08-10	13/16"X16	16	10	O014	29	13	22
TL-14211-10-08	1"X14	12	08	O016	32.5	15.5	27
TL-14211-10-10	1"X14	16	10	O016	33	15.5	27
TL-14211-12-08	1.3/16"X12	12	08	O018	35.5	17	32
TL-14211-12-10	1.3/16"X12	16	10	O018	36	17	32
TL-14211-12-12	1.3/16"X12	20	12	O018	36.5	17	32
TL-14211-16-12	1.7/16"X12	20	12	O021	38	17.5	38
TL-14211-16-16	1.7/16"X12	25	16	O021	39.7	17.5	38
TL-14211-20-20	1.11/16"X12	32	20	O025	41.5	17.5	46
TL-14211-24-24	2"X12	40	24	O029	43.5	17.5	55

Note: 1. For use with braided hoses. 2. If use with spiral hoses, hose fitting series number is TL-14212-xx-xx.

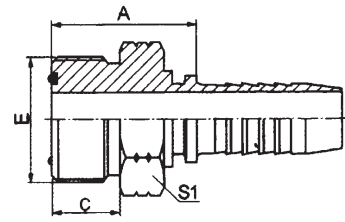

# TL-24211 · TL-24211-T

ORFS. Female. Flat seal. ISO 8434-3 - SAE J1453

PART NO.	THREAD E	HOSE BORE		DIMENSIONS		
		DN	DASH	A	C	S2
TL-24211-04-04T	9/16"X18	6	04	23	8	19
TL-24211-06-06T	11/16"X16	10	06	24	9	22
TL-24211-08-08T	13/16"X16	12	08	26	11	27
TL-24211-10-10T	1"X14	16	10	30.5	12.5	30
TL-24211-12-12T	1.3/16"X12	20	12	32.5	14	36
TL-24211-16-16T	1.7/16"X12	25	16	34.7	15	41
TL-24211-20-20	1.11/16"X12	32	20	41	15	50
TL-24211-24-24	2"X12	40	24	40	17	60

Note: 1. For use with braided hoses. 2. If use with spiral hoses, hose fitting series number is TL-24212-xx-xx.

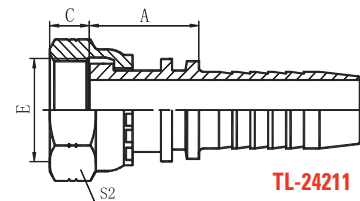

TL-24211

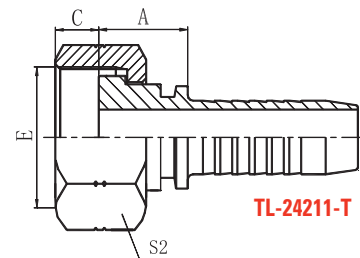

TL-24211-T

# TL-24241 · TL-24241-T

ORFS. Female. Elbow 45°. Flat seal. ISO12151-1 - SAE J516

PART NO.	THREAD E	HOSE BORE		DIMENSIONS			
		DN	DASH	A	H	C	S2
TL-24241-04-04T	9/16"X18	6	04	35.5	20	8	19
TL-24241-06-06T	11/16"X16	10	06	46	20	9	22
TL-24241-08-08T	13/16"X16	12	08	57.5	23.5	11	27
TL-24241-10-10T	1"X14	16	10	66	25	12.5	30
TL-24241-12-12T	1.3/16"X12	20	12	73.5	25	14	36
TL-24241-16-16T	1.7/16"X12	25	16	79.7	29.7	15	41
TL-24241-20-20	1.11/16"X12	32	20	104.5	46	15	50
TL-24241-24-24	2"X12	40	24	123	53	17	60

Note: 1. For use with braided hoses. 2. If use with spiral hoses, hose fitting series number is TL-24242-xx-xx.

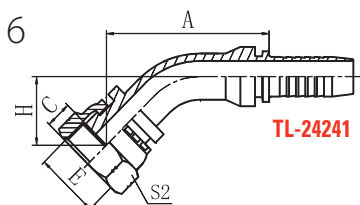

TL-24241

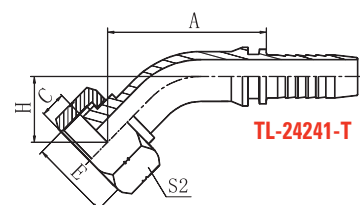

TL-24241-T

# TL-24291 · TL-24291-T

ORFS. Female. Elbow 90°. Flat seal. ISO12151-1 - SAE J516

PART NO.	THREAD E	HOSE BORE		DIMENSIONS			
		DN	DASH	A	H	C	S2
TL-24291-04-04T	9/16"X18	6	04	30	28	8	19
TL-24291-06-06T	11/16"X16	10	06	35	37	9	22
TL-24291-08-08T	13/16"X16	12	08	41.5	46	11	27
TL-24291-10-10T	1"X14	16	10	54	47.5	12.5	30
TL-24291-12-12T	1.3/16"X12	20	12	62	55	14	36
TL-24291-16-16T	1.7/16"X12	25	16	72.2	68	15	41
TL-24291-20-20	1.11/16"X12	32	20	91.5	96	15	50
TL-24291-24-24	2"X12	40	24	108	110	17	60

Note: 1. For use with braided hoses. 2. If use with spiral hoses, hose fitting series number is TL-24292-xx-xx.

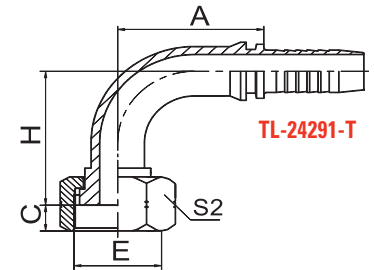
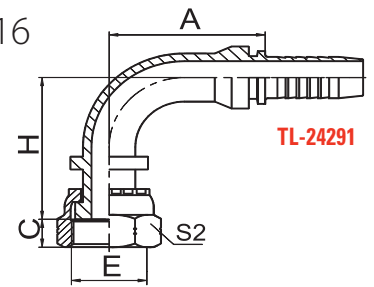

# TL-21611 · TL-21612

NPSM. Female. 60° Cone seat. SAE J514

PART NO.	THREAD E	HOSE BORE		DIMENSIONS		
		DN	DASH	A	B	S2
TL-21611-04-04	1/4"X18	6	04	18.5	5	19
TL-21611-06-06	3/8"X18	10	06	20.5	6.5	22
TL-21611-08-08	1/2"X14	12	08	22.5	7.8	27
TL-21611-12-12	3/4"X14	20	12	24	10.5	32
TL-21611-16-16	1"X11.5	25	16	27.7	11	41
TL-21611-20-20	1.1/4"X11.5	32	20	31	11.5	50
TL-21611-24-24	1.1/2"X11.5	40	24	32	12.5	55
TL-21611-32-32	2"X11.5	50	32	31	16	70

Note: 1. For use with braided hoses. 2. If use with spiral hoses, hose fitting series number is TL-21612-xx-xx.

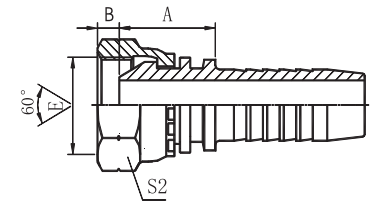

# TL-21641 · TL-21642

NPSM. Female. Elbow 45°. 60° Cone seat. SAE J514

PART NO.	THREAD E	HOSE BORE		DIMENSIONS			
		DN	DASH	A	B	H	S2
TL-21641-04-04	1/4"X18	6	04	42.5	5	20	22
TL-21641-06-06	3/8"X18	10	06	47	6.5	22.5	22
TL-21641-08-08	1/2"X14	12	08	61	7.8	26	27
TL-21641-12-12	3/4"X14	20	12	79.5	10.5	32	32
TL-21641-16-16	1"X11.5	25	16	88.7	11	34	41
TL-21641-20-20	1.1/4"X11.5	32	20	100.5	11.5	40	50
TL-21641-24-24	1.1/2"X11.5	40	24	116	12.5	45	55
TL-21641-32-32	2"X11.5	50	32	136.4	16	63.4	70

Note: 1. For use with braided hoses. 2. If use with spiral hoses, hose fitting series number is TL-21642-xx-xx.

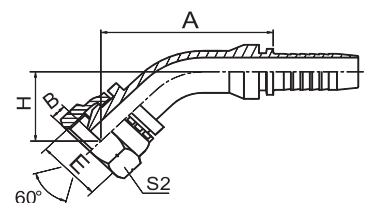

# TL-21691 · TL-21692

NPSM. Female. Elbow 90°. 60° Cone seat. SAE J514

PART NO.	THREAD E	HOSE BORE		DIMENSIONS			
		DN	DASH	A	B	H	S2
TL-21691-04-04	1/4"X18	6	04	30	5	36.5	19
TL-21691-06-06	3/8"X18	10	06	35	6.5	43	22
TL-21691-08-08	1/2"X14	12	08	41	7.8	51	27
TL-21691-12-12	3/4"X14	20	12	65.5	10.5	66	32
TL-21691-16-16	1"X11.5	25	16	76.7	11	74	41
TL-21691-20-20	1.1/4"X11.5	32	20	91.5	11.5	87	50
TL-21691-24-24	1.1/2"X11.5	40	24	110	12.5	102	55
TL-21691-32-32	2"X11.5	50	32	131.8	16	124.5	70

Note: 1. For use with braided hoses. 2. If use with spiral hoses, hose fitting series number is TL-21692-xx-xx.

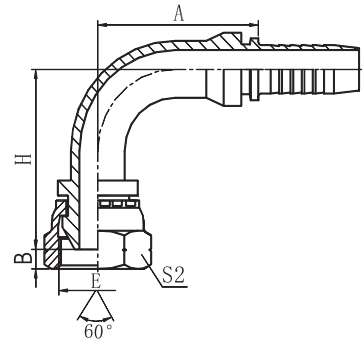

# TL-87312

SAE Flange. 3000 Psi. SAE J516

PART NO.	FLANGE SIZE	HOSE BORE		DIMENSIONS			
		DN	DASH	A	C	D	L
TL-87312-08-08	1/2"	12	08	46	30.2	23.9	7
TL-87312-12-08	3/4"	12	08	47	38.1	31.7	7
TL-87312-12-10	3/4"	16	10	48	38.1	31.7	7
TL-87312-12-12	3/4"	20	12	49.3	38.1	31.7	7
TL-87312-12-16	3/4"	25	16	50	38.1	31.7	7
TL-87312-16-12	1"	20	12	50.3	44.4	38	8.2
TL-87312-16-16	1"	25	16	52	44.4	38	8.2
TL-87312-16-20	1"	32	20	53	44.4	38	8.2
TL-87312-20-16	1.1/4"	25	16	57	50.8	43.2	8.2
TL-87312-20-20	1.1/4"	32	20	59	50.8	43.2	8.2
TL-87312-24-20	1.1/2"	32	20	68	60.3	50.3	8.2
TL-87312-24-24	1.1/2"	40	24	70	60.3	50.3	8.2
TL-87312-32-24	2"	40	24	70	71.4	62.2	9.8
TL-87312-32-32	2"	50	32	70	71.4	62.2	9.8
TL-87312-40-40	2.1/2"	64	40	76	84.1	74	9.53

Note: 1. For use with spiral hoses. 2. If use with braided hoses, hose fitting series number is TL-87311-xx-xx.

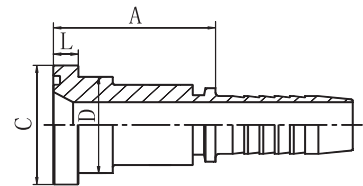

# TL-87342

SAE Flange. 3000 Psi. Elbow 45°. ISO12151-3 - SAE J516

PART NO.	FLANGE SIZE	HOSE BORE		DIMENSIONS				
		DN	DASH	A	C	D	H	L
TL-87342-08-08	1/2"	12	08	58.5	30.2	23.9	23.3	7
TL-87342-12-08	3/4"	12	08	59	38.1	31.7	24	7
TL-87342-12-10	3/4"	16	10	70	38.1	31.7	25.3	7
TL-87342-12-12	3/4"	20	12	77.3	38.1	31.7	29	7
TL-87342-16-12	1"	20	12	77.3	44.4	38	29	8.2
TL-87342-16-16	1"	25	16	85	44.4	38	29.7	8.2
TL-87342-16-20	1"	32	20	94	44.4	38	34	8.2
TL-87342-20-16	1.1/4"	25	16	85	50.8	43.2	29.7	8.2
TL-87342-20-20	1.1/4"	32	20	94.5	50.8	43.2	33.8	8.2
TL-87342-24-20	1.1/2"	32	20	101	60.3	50.3	37	8.2
TL-87342-24-24	1.1/2"	40	24	110	60.3	50.3	39	8.2
TL-87342-32-24	2"	40	24	110	71.4	62.2	39	9.8
TL-87342-32-32	2"	50	32	141	71.4	62.2	48.3	9.8

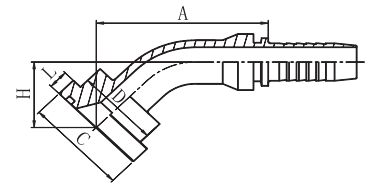

Note: 1. For use with spiral hoses. 2. If use with braided hoses, hose fitting series number is TL-87341-xx-xx.

# TL-87392

SAE Flange. 3000 Psi. Elbow 90°. ISO12151-3 - SAE J516

PART NO.	FLANGE SIZE	HOSE BORE		DIMENSIONS				
		DN	DASH	A	C	D	H	L
TL-87392-08-08	1/2"	12	08	41	30.2	23.9	47	7
TL-87392-12-08	3/4"	12	08	48.5	38.1	31.7	48	7
TL-87392-12-10	3/4"	16	10	56.5	38.1	31.7	52.5	7
TL-87392-12-12	3/4"	20	12	66.3	38.1	31.7	62	7
TL-87392-12-12(H100)	3/4"	20	12	66.3	38.1	31.7	100	7
TL-87392-12-12(H127)	3/4"	20	12	65.5	38.1	31.7	127	6.73
TL-87392-12-12(H150)	3/4"	20	12	65.5	38.1	31.7	150	6.73
TL-87392-12-16	3/4"	25	16	78	38.1	31.7	67.5	7
TL-87392-16-12	1"	20	12	66.3	44.4	38	62	8.2
TL-87392-16-16	1"	25	16	78	44.4	38	67.5	8.2
TL-87392-16-16(H100)	1"	25	16	76.7	44.4	38	100	8
TL-87392-16-16(H127)	1"	25	16	76.7	44.4	38	127	8
TL-87392-16-16(H150)	1"	25	16	76.7	44.4	38	150	8
TL-87392-16-20	1"	32	20	91	44.4	38	78.5	8.2
TL-87392-20-16	1.1/4"	25	16	78	50.8	43.2	67.5	8.2
TL-87392-20-20	1.1/4"	32	20	91.5	50.8	43.2	78.5	8
TL-87392-20-20(H100)	1.1/4"	32	20	91.5	50.8	43	100	8
TL-87392-20-20(H127)	1.1/4"	32	20	91.5	50.8	43	127	8
TL-87392-20-20(H150)	1.1/4"	32	20	91.5	50.8	43	150	8
TL-87392-20-24	1.1/4"	40	24	112	50.8	43.2	92	8.2
TL-87392-24-20	1.1/2"	32	20	91.5	60.3	50.3	80.5	8.2
TL-87392-24-24	1.1/2"	40	24	111	60.3	50.3	94	8.2
TL-87392-24-24(H127)	1.1/2"	40	24	109.4	60.3	50	127	8
TL-87392-32-24	2"	40	24	111	71.4	62.2	94	9.8
TL-87392-32-32	2"	50	32	132	71.4	62.2	114.3	9.8
TL-87392-40-32	2.1/2"	50	32	131.8	84.1	74.4	114.3	95.3

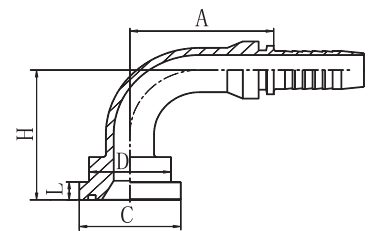

Note: 1. For use with spiral hoses. 2. If use with braided hoses, hose fitting series number is TL-87391-xx-xx.

# TL-87612

SAE Flange. 6000 Psi. ISO12 151-3 - SAE J516

PART NO.	FLANGE SIZE	HOSE BORE		DIMENSIONS			
		DN	DASH	A	C	D	L
TL-87612-08-08	1/2"	12	08	47	31.8	23.9	7.9
TL-87612-12-10	3/4"	16	10	51	41.3	31.7	8.9
TL-87612-12-12	3/4"	20	12	51.3	41.3	31.7	8.9
TL-87612-16-12	1"	20	12	56.3	47.6	38	9.6
TL-87612-16-16	1"	25	16	57	47.6	38	9.6
TL-87612-16-20	1"	32	20	61	47.6	38	9.6
TL-87612-20-16	1.1/4"	25	16	65	54	43.6	10.4
TL-87612-20-20	1.1/4"	32	20	66	54	43.6	10.4
TL-87612-24-20	1.1/2"	32	20	75	63.5	50.8	12.7
TL-87612-24-24	1.1/2"	40	24	75	63.5	50.8	12.7
TL-87612-32-24	2"	40	24	85	79.4	66.5	12.7
TL-87612-32-32	2"	50	32	85	79.4	66.5	12.7

Note: 1. For use with spiral hoses. 2. If use with braided hoses, hose fitting series number is TL-87611-xx-xx.

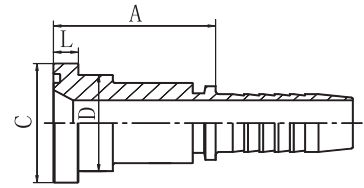

# TL-87642

SAE Flange. 6000 Psi. Elbow 45°. ISO12151-3 - SAE J516

PART NO.	FLANGE SIZE	HOSE BORE		DIMENSIONS				
		DN	DASH	A	C	D	H	L
TL-87642-08-08	1/2"	12	08	59	31.8	23.9	24	7.9
TL-87642-08-12	3/4"	20	12	79.8	31.8	23.9	31.8	7.9
TL-87642-12-10	3/4"	16	10	72.5	41.3	31.7	28	8.9
TL-87642-12-12	3/4"	20	12	79.3	41.3	31.7	31.8	8.9
TL-87642-16-16	1"	25	16	90	47.6	38	34.7	9.6
TL-87642-20-20	1.1/4"	32	20	104	54	43.6	41.5	10.4
TL-87642-24-20	1.1/2"	32	20	106	63.5	50.8	45	12.7
TL-87642-24-24	1.1/2"	40	24	120	63.5	50.8	46	12.7
TL-87642-32-24	2"	40	24	125	79.4	66.5	55	12.7
TL-87642-32-32	2"	50	32	136	79.4	66.5	52.7	12.7

Note: 1. For use with spiral hoses. 2. If use with braided hoses, hose fitting series number is TL-87641-xx-xx.

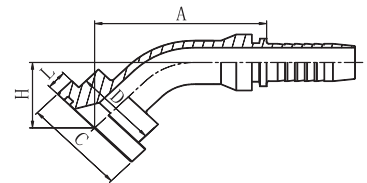

# TL-87692

SAE Flange. 6000 Psi. Elbow 90°. ISO12151-3 - SAE J516

PART NO.	FLANGE SIZE	HOSE BORE		DIMENSIONS				
		DN	DASH	A	C	D	H	L
TL-87692-08-08	1/2"	12	08	41	31.8	23.9	48	7.9
TL-87692-12-10	3/4"	16	10	56.5	41.3	31.7	56.5	8.9
TL-87692-12-12	3/4"	20	12	66.3	41.3	31.7	66	8.9
TL-87692-16-12	1"	20	12	65.8	47.6	38	69	9.6
TL-87692-16-16	1"	25	16	78	47.6	38	74.5	9.6
TL-87692-16-20	1"	32	20	91	47.6	38	85.5	9.6
TL-87692-20-16	1.1/4"	25	16	78	54	43.6	78.5	10.4
TL-87692-20-20	1.1/4"	32	20	91.5	54	43.6	89.5	10.4
TL-87692-24-20	1.1/2"	32	20	91.5	63.5	50.8	94.5	12.7
TL-87692-24-24	1.1/2"	40	24	110	63.5	50.8	108	12.7
TL-87692-32-24	2"	40	24	110	79.4	66.5	116	12.7
TL-87692-32-32	2"	50	32	132	79.4	66.5	136	12.7

Note: 1. For use with spiral hoses. 2. If use with braided hoses, hose fitting series number is TL-87691-xx-xx.

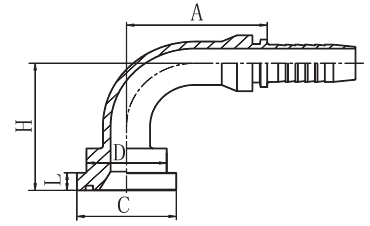

# TL-88112

JIS Flange

PART NO.	FLANGE SIZE	HOSE BORE		DIMENSIONS			
		DN	DASH	A	C	D	L
TL-88112-10-08	5/8"	12	08	45	34.2	27.8	6.7
TL-88112-10-10	5/8"	16	10	46	34.2	27.8	6.7
TL-88112-10-12	5/8"	20	12	46.3	34.2	27.8	6.7

Note: 1. For use with spiral hoses. 2. If use with braided hoses, hose fitting series number is TL-88111-xx-xx.

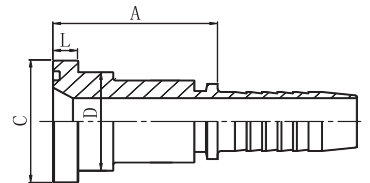

# TL-88142

JIS Flange. Elbow 45°

PART NO.	FLANGE SIZE	HOSE BORE		DIMENSIONS				
		DN	DASH	A	C	D	H	L
TL-88142-10-08	5/8"	12	08	60	34.2	27.8	24	6.7
TL-88142-10-10	5/8"	16	10	70.1	34.2	27.8	25.3	6.7
TL-88142-10-12	5/8"	20	12	77.3	34.2	27.8	29	6.7

Note: 1. For use with spiral hoses. 2. If use with braided hoses, hose fitting series number is TL-88141-xx-xx.

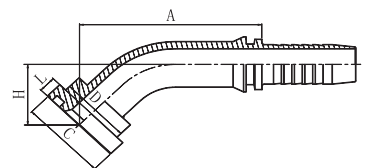

# TL-88192

JIS Flange. Elbow 90°

PART NO.	FLANGE SIZE	HOSE BORE		DIMENSIONS				
		DN	DASH	A	B	D	H	L
TL-88192-10-08	5/8"	12	08	41	34.2	27.8	48	6.7
TL-88192-10-10	5/8"	16	10	56.5	34.2	27.8	52.5	6.7
TL-88192-10-12	5/8"	20	12	66.3	34.2	27.8	62	6.7

Note: 1. For use with spiral hoses. 2. If use with braided hoses, hose fitting series number is TL-88191-xx-xx.

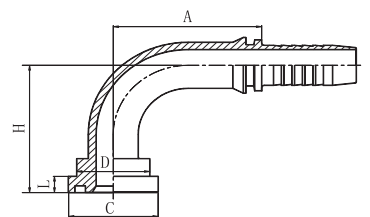



# TL-18611 · TL-18612

JIS. Male. Metric. 60° Cone seat

PART NO.	THREAD E	HOSE BORE		DIMENSIONS		
		DN	DASH	A	B	S1
TL-18611-14-04	M14X1.5	6	04	29.5	17	17
TL-18611-14-06	M14X1.5	10	06	29.5	17	17
TL-18611-16-04	M16X1.5	6	04	30.5	18	17
TL-18611-16-06	M16X1.5	10	06	30.5	18	17
TL-18611-18-06	M18X1.5	10	06	30.5	18	19
TL-18611-20-08	M20X1.5	12	08	35	20	22
TL-18611-22-08	M22X1.5	12	08	35	20	24
TL-18611-24-10	M24X1.5	16	10	38.5	21.5	27
TL-18611-30-12	M30X1.5	20	12	45	26	32
TL-18611-33-16	M33X1.5	25	16	50.5	30	36
TL-18611-36-20	M36X1.5	32	20	55	33	38
TL-18611-42-24	M42X1.5	40	24	60	36	46

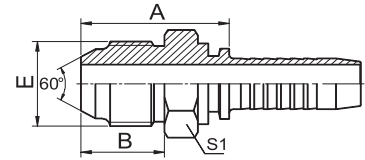

Note: 1. For use with braided hoses. 2. If use with spiral hoses, hose fitting series number is TL-18612-xx-xx.

# TL-28611 · TL-28612

JIS. Female. Metric. 60° Cone seat

PART NO.	THREAD E	HOSE BORE		DIMENSIONS			
		DN	DASH	A	C	S1	S2
TL-28611-12-04	M12X1.5	6	04	22	7.5	17	17
TL-28611-14-04	M14X1.5	6	04	23.5	8	19	19
TL-28611-14-06	M14X1.5	10	06	24	8	19	19
TL-28611-16-04	M16X1.5	6	04	25.5	7.5	22	22
TL-28611-16-05	M16X1.5	8	05	25.5	7.5	22	22
TL-28611-16-06	M16X1.5	10	06	25.5	7.5	22	22
TL-28611-18-06	M18X1.5	10	06	27	8.5	24	24
TL-28611-18-08	M18X1.5	12	08	27.5	8.5	24	24
TL-28611-20-08	M20X1.5	12	08	27.5	9	27	27
TL-28611-22-08	M22X1.5	12	08	27.5	9	27	27
TL-28611-24-08	M24X1.5	12	08	28	10.5	32	30
TL-28611-24-10	M24X1.5	16	10	28.5	10.5	32	30
TL-28611-27-10	M27X1.5	16	10	32	9	32	32
TL-28611-30-12	M30X1.5	20	12	32.5	11	36	36
TL-28611-33-12	M33X1.5	20	12	34.5	13.5	41	41
TL-28611-33-16	M33X1.5	25	16	36.2	13.5	41	41
TL-28611-36-20	M36X1.5	32	20	38.5	12	46	41
TL-28611-42-24W	M42X1.5	40	24	41	15.5	55	50

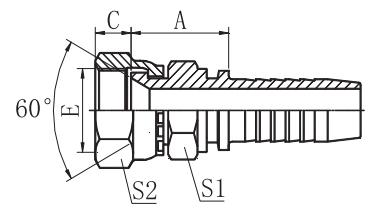

Note: 1. For use with braided hoses. 2. If use with spiral hoses, hose fitting series number is TL-28612-xx-xx.

## TL-28641 · TL-28642

JIS. Female. Metric. Elbow 45°. 60° Cone seat

PART NO.	THREAD E	HOSE BORE		DIMENSIONS				
		DN	DASH	A	C	H	S1	S2
TL-28641-14-04	M14X1.5	6	04	43.5	8	21.3	19	19
TL-28641-16-05	M16X1.5	8	05	47.5	7.5	24.3	22	22
TL-28641-18-06	M18X1.5	10	06	49.5	8.5	25	24	24
TL-28641-22-08	M22X1.5	12	08	62	9	27.2	27	27
TL-28641-24-10	M24X1.5	16	10	74.5	10.5	30	32	30
TL-28641-30-12	M30X1.5	20	12	81	11	33.5	36	36
TL-28641-33-16	M33X1.5	25	16	90.7	13.5	35.7	41	41
TL-28641-36-20	M36X1.5	32	20	104.5	12	42	46	41
TL-28641-42-24W	M42X1.5	40	24	117	15.5	47.5	55	50

Note: 1. For use with spiral hoses. 2. If use with spiral hoses, hose fitting series number is TL-28642-xx-xx.

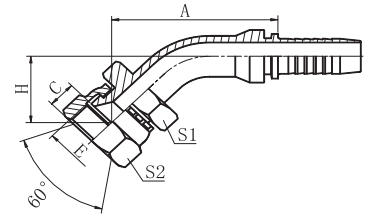

## TL-28691 · TL-28692

JIS. Female. Metric. Elbow 90°. 60° Cone seat

PART NO.	THREAD E	HOSE BORE		DIMENSIONS				
		DN	DASH	A	C	H	S1	S2
TL-28691-14-04	M14X1.5	6	04	30	8	38	19	19
TL-28691-14-06	M14X1.5	10	06	35	8	43.5	19	19
TL-28691-16-05	M16X1.5	8	05	33	7.5	44	22	22
TL-28691-18-06	M18X1.5	10	06	35	8.5	46.5	24	24
TL-28691-22-08	M22X1.5	12	08	41.5	9	52.5	27	27
TL-28691-24-10	M24X1.5	16	10	56.5	10.5	59	32	30
TL-28691-30-12	M30X1.5	20	12	65.5	11	68.5	36	36
TL-28691-33-16	M33X1.5	25	16	76.7	13.5	80	41	41
TL-28691-36-20	M36X1.5	32	20	93	12	95	46	41
TL-28691-42-24	M42X1.5	40	24	108	15.5	110	55	50

Note: 1. For use with spiral hoses. 2. If use with spiral hoses, hose fitting series number is TL-28692-xx-xx.

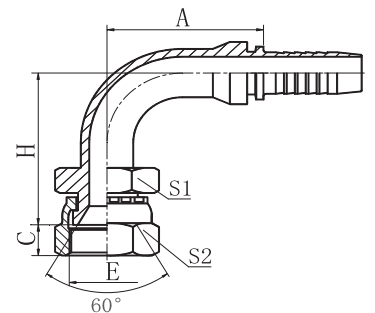

## TL-29611D · TL-29611D

JIS. Female. Gas. 60° Cone seat. JIS B6363

PART NO.	THREAD E	HOSE BORE		DIMENSIONS			
		DN	DASH	A	C	S1	S2
TL-29611D-02-03	G1/8"X28	5	03	20	7	14	14
TL-29611D-04-04	G1/4"X19	6	04	22.5	7.5	19	19
TL-29611D-04-05	G1/4"X19	8	05	21	7.5	19	19
TL-29611D-06-04	G3/8"X19	6	04	24	9.5	22	22
TL-29611D-06-06	G3/8"X19	10	06	25	9.5	22	22
TL-29611D-08-06	G1/2"X14	10	06	26	11.3	27	27
TL-29611D-08-08	G1/2"X14	12	08	26.5	11.3	27	27
TL-29611D-10-10	G5/8"X14	16	10	29	12	30	30
TL-29611D-12-10	G3/4"X14	16	10	29	13	32	32
TL-29611D-12-12	G3/4"X14	20	12	29.5	13	32	32
TL-29611D-16-16	G1"X11	25	16	34.7	14	41	41
TL-29611D-20-20	G1.1/4"X11	32	20	43	18.5	50	50
TL-29611D-24-24	G1.1/2"X11	40	24	43.5	19	55	55
TL-29611D-32-32	G2"X11	50	32	46.5	23	70	70

Note: 1. For use with braided hoses. 2. If use with spiral hoses, hose fitting series number is TL-29612-xx-xx.

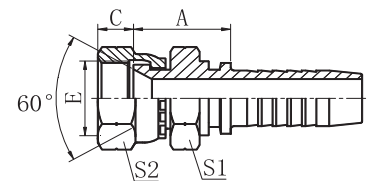

# TL-29641D · TL-29642D

JIS. Female. Gas. Elbow 45°. 60° Cone seat. JIS B6363

PART NO.	THREAD E	HOSE BORE		DIMENSIONS				
		DN	DASH	A	C	H	S1	S2
TL-29641D-04-04D	G1/4"X19	6	04	43.5	7.5	21.3	19	19
TL-29641D-06-06	G3/8"X19	10	06	50	9.5	24.6	22	22
TL-29641D-08-08	G1/2"X14	12	08	62.5	11.3	27.5	27	27
TL-29641D-12-12	G3/4"X14	20	12	81	13	33.9	32	32
TL-29641D-16-16	G1"X11	25	16	87.7	14	36	41	41
TL-29641D-20-20	G1.1/4"X11	32	20	107.3	18.5	46.5	50	50
TL-29641D-24-24	G1.1/2"X11	40	24	122.8	19	50.8	55	55
TL-29641D-32-32	G2"X11	50	32	143	23	60	70	70

Note: 1. For use with spiral hoses. 2. If use with spiral hoses, hose fitting series number is TL-29642-xx-xx.

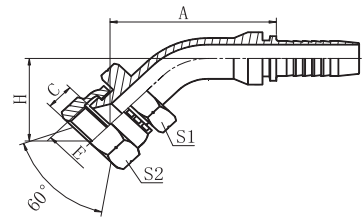

# TL-29691-D · TL-29692-D

JIS. Female. Gas. Elbow 90°. 60° Cone seat. JIS B6363

PART NO.	THREAD E	HOSE BORE		DIMENSIONS				
		DN	DASH	A	C	H	S1	S2
TL-29691D-04-04	G1/4"X19	6	04	30	7.5	38	19	19
TL-29691D-04-05	G1/4"X19	8	05	33	8	41	19	19
TL-29691D-06-06	G3/8"X19	10	06	35	9.5	46.5	22	22
TL-29691D-08-08	G1/2"X14	12	08	41.5	11.3	53	27	27
TL-29691D-10-10	G5/8"X14	16	10	56	12	61	30	30
TL-29691D-12-12	G3/4"X14	20	12	65.5	13	69	32	32
TL-29691D-16-16	G1"X11	25	16	76.7	14	76.5	41	41
TL-29691D-20-20	G1.1/4"X11	32	20	91.5	15.5	93	50	50
TL-29691D-24-24	G1.1/2"X11	40	24	109.5	17.5	110.5	55	55
TL-29691D-32-32	G2"X11	50	32	131.8	23	133.8	70	70

Note: 1. For use with spiral hoses. 2. If use with spiral hoses, hose fitting series number is TL-29692-xx-xx.

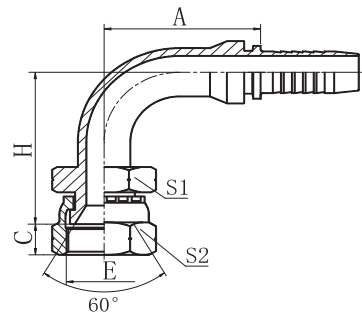

# TL-20011-T

Metric. Female. Waterwash insert

PART NO.	THREAD E	HOSE BORE		O-RING	DIMENSIONS		
		DN	DASH		A	d	D
TL-20011-22-04T	M22X1.5	6	04	O10.0X2.0	33	14	34.5
TL-20011-22-05T	M22X1.5	8	05	O10.0X2.0	33	14	34.5
TL-20011-22-06T	M22X1.5	10	06	O10.0X2.0	33	14	34.5

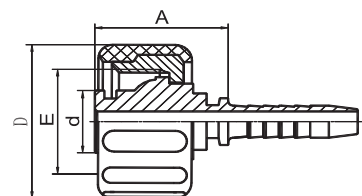

# TL-60011 · TL-60012

Male. Staplelock

PART NO.	HOSE BORE		DIMENSIONS			
	DN	DASH	A	C	J	K
TL-60011-04-04	6	04	31	25	15	11
TL-60011-05-05	8	05	33.5	26	18	13
TL-60011-06-06	10	06	33	26	18	15
TL-60011-08-06	10	06	33.5	26	22	18
TL-60011-08-08	12	08	34	26	22	18
TL-60011-10-10	16	10	39	30	25	20
TL-60011-12-12	20	12	40.5	31	28	24
TL-60011-16-14	22	14	41	31	35	30
TL-60011-16-16	25	16	42.2	31	35	30

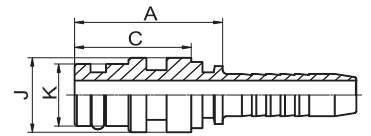

Note: 1. For use with braided hoses. 2. If use with spiral hoses, hose fitting series number is TL-60012-xx-xx.

# TL-67011 · TL-67012

SAE: Male. Staplelock. SAE J1467

PART NO.	HOSE BORE		O-RING	DIMENSIONS			
	DN	DASH		A	C	J	K
TL-67011-04-04	6	04	O0.60X2.0	34.5	28	14.9	10
TL-67011-06-06	10	06	O10.0X2.0	35	28	19.9	14
TL-67011-08-08	12	08	O13.0X2.5	36	28	23.9	18
TL-67011-12-12	20	12	O19.0X2.5	37.5	28	28.9	24
TL-67011-16-16	25	16	O25.0X2.5	44.2	33	38.8	31
TL-67011-20-20	32	20	O33.0X2.5	44.5	33	45.9	38
TL-67011-24-24	40	24	O40.0X3.0	48.5	36.3	54.9	46.7
TL-67011-32-32	50	32	O50.0X3.0	47.5	36.3	63.9	55.9

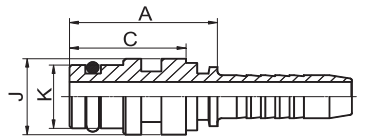

Note: 1. For use with braided hoses. 2. If use with spiral hoses, hose fitting series number is TL-67012-xx-xx.

# TL-70011 · TL-70012

Metric. Banjo. Orientable. DIN 7642

PART NO.	BOLT	HOSE BORE		DIMENSIONS			
		DN	DASH	A	d	D	H
TL-70011-10-03	M10X1	5	03	14.5	10.1	17	10
TL-70011-10-04	M10X1	6	04	16.5	10.1	17	10
TL-70011-12-04	M12X1.5	6	04	20.5	12.1	20	12
TL-70011-12-05	M12X1.5	8	05	20.5	12.1	20	12
TL-70011-12-06	M12X1.5	10	06	20.5	12.1	20	12
TL-70011-14-04	M14X1.5	6	04	21	14.1	24	14
TL-70011-14-05	M14X1.5	8	05	21	14.1	24	14
TL-70011-14-06	M14X1.5	10	06	21	14.1	24	14
TL-70011-16-04	M16X1.5	6	04	20.5	16.1	28	16
TL-70011-16-05	M16X1.5	8	05	20.5	16.1	28	16
TL-70011-16-06	M16X1.5	10	06	20.5	16.1	28	16
TL-70011-18-04	M18X1.5	6	04	23	18.1	32	20
TL-70011-18-05	M18X1.5	8	05	24	18.1	32	20
TL-70011-18-06	M18X1.5	10	06	24	18.1	32	20
TL-70011-18-08	M18X1.5	12	08	24.5	18.1	32	20
TL-70011-22-06	M22X1.5	10	06	27.5	22.1	39	25
TL-70011-22-08	M22X1.5	12	08	28	22.1	39	25

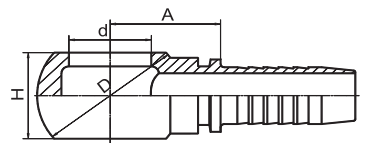

NEXT >

PART NO.	BOLT	HOSE BORE		DIMENSIONS			
		DN	DASH	A	d	D	H
TL-70011-22-10	M22X1.5	16	10	28	22.1	39	25
TL-70011-26-12	M26X1.5	20	12	32.5	26.1	46	30
TL-70011-30-16	M30X1.5	25	16	36.7	30.1	54	36
TL-70011-30-20	M30X1.5	32	20	41	30.1	54	36

Note: 1. For use with braided hoses. 2. If use with spiral hoses, hose fitting series number is TL-70012-xx-xx.

## TL-700M

Metric. Bolt for banjo. DIN 7643

PART NO.	THREAD E	DIMENSIONS			
		A	B	C	S1
TL-700M-10	M10X1	19	5.5	6	14
TL-700M-12	M12X1.5	24	7	6	17
TL-700M-14	M14X1.5	26	9	6	19
TL-700M-16	M16X1.5	28	11	6	22
TL-700M-18	M18X1.5	32	13	6	24
TL-700M-22	M22X1.5	39	16	7	27
TL-700M-26	M26X1.5	45	20	7	32
TL-700M-30	M30X1.5	51	24	7	36

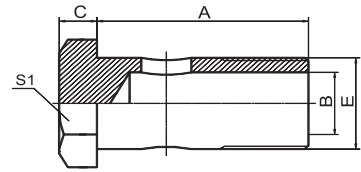

## TL-72011 · TL-72012

BSP. Banjo. Orientable

PART NO.	BOLT	HOSE BORE		DIMENSIONS			
		DN	DASH	A	d	D	H
TL-72011-02-03	G1/8"X28	5	03	18.5	9.9	22	16
TL-72011-02-04	G1/8"X28	6	04	18.5	9.9	22	16
TL-72011-04-03	G1/4"X19	5	03	19	13.3	24	15
TL-72011-04-04	G1/4"X19	6	04	19.5	13.3	24	15
TL-72011-04-05	G1/4"X19	8	05	19	13.3	24	15
TL-72011-04-06	G1/4"X19	10	06	19	13.3	24	15
TL-72011-06-04	G3/8"X19	6	04	22	16.7	29	20
TL-72011-06-05	G3/8"X19	8	05	22	16.7	29	20
TL-72011-06-06	G3/8"X19	10	06	22	16.7	29	20
TL-72011-06-08	G3/8"X19	12	08	23	16.7	29	20
TL-72011-08-05	G1/2"X14	8	05	27.5	21	38	25
TL-72011-08-06	G1/2"X14	10	06	27	21	38	25
TL-72011-08-08	G1/2"X14	12	08	27.5	21	38	25
TL-72011-08-10	G1/2"X14	16	10	29	21	38	25
TL-72011-10-10	G5/8"X14	16	10	28	23	40	27
TL-72011-12-10	G3/4"X14	16	10	32	26.5	48	31
TL-72011-12-12	G3/4"X14	20	12	32	26.5	48	31
TL-72011-16-08	G1"X11	12	08	40	33.3	60	42
TL-72011-16-12	G1"X11	20	12	40	33.3	60	42
TL-72011-16-16	G1"X11	25	16	41	33.3	60	42

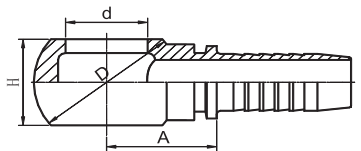

Note: 1. For use with braided hoses. 2. If use with spiral hoses, hose fitting series number is TL-72012-xx-xx.

## TL-720B

BSP. Bolt for banjo

PART NO.	THREAD E	DIMENSIONS			
		A	B	C	S1
TL-720B-02	G1/8"X28	29.5	4.8	4.8	14
TL-720B-04	G1/4"X19	28.5	6	6	19
TL-720B-06	G3/8"X19	38.5	9	7	22
TL-720B-08	G1/2"X14	44	13	8.5	27
TL-720B-10	G5/8"X14	48.5	15	10	30
TL-720B-12	G3/4"X14	56	18.5	10	32
TL-720B-16	G1"X11	68.5	22	13	41

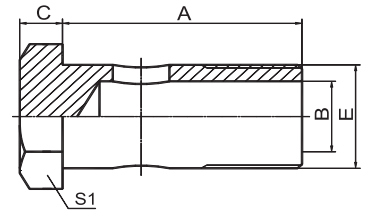

## TL-15611SW

NPT. Male. Swivel

PART NO.	THREAD E	HOSE BORE		DIMENSIONS	
		DN	DASH	A	S2
TL-15611SW-04-04	Z1/4"X18	6	04	36.5	17
TL-15611SW-06-06	Z3/8"X18	10	06	40.3	22
TL-15611SW-08-08	Z1/2"X14	12	08	43	24
TL-15611SW-12-12	Z3/4"X14	20	12	68.4	32
TL-15611SW-16-16	Z1"	25	16	63.7	36
TL-15611SW-20-20	Z1.1/4"	32	20	71	46

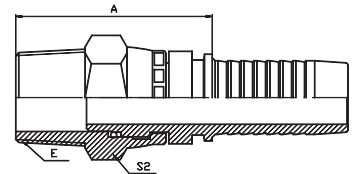

## TL-16011SW

SAE. Male. ORB. Swivel

PART NO.	THREAD E	HOSE BORE		O-RING	DIMENSIONS	
		DN	DASH		A	S2
TL-16011SW-08-06	3/4"X16	10	06	O908	57.5	27
TL-16011SW-08-08	3/4"X16	12	08	O908	58	27
TL-16011SW-10-08	7/8"X14	12	08	O910	59.5	27
TL-16011SW-10-10	7/8"X14	16	10	O910	60.1	27
TL-16011SW-12-12	1.1/16"X12	20	12	O912	64.9	32

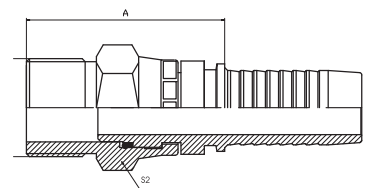

# TL-90011

## Double connector

PART NO.	HOSE BORE		DIMENSIONS
	DN	DASH	
TL-90011-04	6	04	69
TL-90011-05	8	05	71
TL-90011-06	10	06	74
TL-90011-08	12	08	77
TL-90011-10	16	10	83
TL-90011-12	20	12	96
TL-90011-16	25	16	114
TL-90011-20	32	20	134
TL-90011-24	40	24	166
TL-90011-32	50	32	182

Note: For wire braid hose.

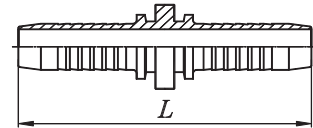

# TL-90012

## Double connector

PART NO.	HOSE BORE		DIMENSIONS
	DN	DASH	
TL-90012-04	6	04	75
TL-90012-05	8	05	78
TL-90012-06	10	06	87
TL-90012-08	12	08	93
TL-90012-10	16	10	97
TL-90012-12	20	12	113
TL-90012-16	25	16	136
TL-90012-20	32	20	156
TL-90012-24	40	24	172
TL-90012-32	50	32	182

Note: For wire braid hose.

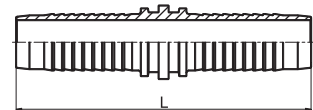

## ONE PIECE FITTINGS

# TL-15611-PK

## NPT. Male

PART NO.	THREAD E	HOSE BORE		DIMENSIONS		
		DN	DASH	A	B	S1
TL-15611-02-04PK	Z1/8"X27	6	04	42.5	22.9	12
TL-15611-04-04PK	Z1/4"X18	6	04	48.5	28.9	14
TL-15611-04-06PK	Z1/4"X18	10	06	52	30	17
TL-15611-06-04PK	Z3/8"X18	6	04	49	29.4	19
TL-15611-06-06PK	Z3/8"X18	10	06	53.5	31.5	19
TL-15611-06-08PK	Z3/8"X18	12	08	59	30.5	19
TL-15611-08-04PK	Z1/2"X14	6	04	53.5	33.9	22
TL-15611-08-06PK	Z1/2"X14	10	06	57.5	35.5	22
TL-15611-08-08PK	Z1/2"X14	12	08	63	34.5	22
TL-15611-08-10PK	Z1/2"X14	16	10	71	33.9	22
TL-15611-12-12PK	Z3/4"X14	20	12	73.5	33.9	27
TL-15611-16-16PK	Z1"X11.5	25	16	90.5	45.5	36
TL-15611-20-20PK	Z1-1/4"X11.5	32	20	95.8	48.8	45
TL-15611-24-24PK	Z1-1/2"X11.5	40	24	91	52.6	50
TL-15611-32-32PK	Z2"X11.5	50	32	103	55.8	64

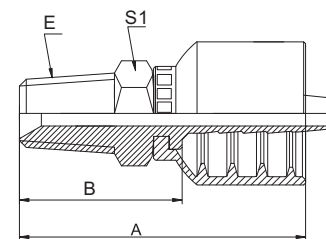

# TL-16711-PK

JIC. Male. 74° Cone seat. ISO 8434-2 - SAE J514

PART NO.	THREAD E	HOSE BORE		DIMENSIONS		
		DN	DASH	A	B	S1
TL-16711-04-04PK	7/16"X20	6	04	45	25.4	14
TL-16711-05-04PK	1/2"X20	6	04	45	25.4	14
TL-16711-06-04PK	9/16"X18	6	04	48.5	28.9	19
TL-16711-06-06PK	9/16"X18	10	06	52	30	19
TL-16711-06-08PK	9/16"X18	12	08	57	28.5	22
TL-16711-08-06PK	3/4"X16	10	06	54	32	22
TL-16711-08-08PK	3/4"X16	12	08	59.5	31	22
TL-16711-10-08PK	7/8"X14	12	08	63.5	35	24
TL-16711-10-10PK	7/8"X14	16	10	71.5	34.4	24
TL-16711-12-12PK	1.1/16"X12	20	12	78	38.4	27
TL-16711-16-12PK	1.5/16"X12	20	12	80.5	40.9	35
TL-16711-16-16PK	1.5/16"X12	25	16	88	43	35
TL-16711-20-20PK	1.5/8"X12	32	20	93.8	46.8	46
TL-16711-24-24PK	1.7/8"X12	40	24	93	54.6	50
TL-16711-32-32PK	2.1/2"X12	50	32	110	62.8	65

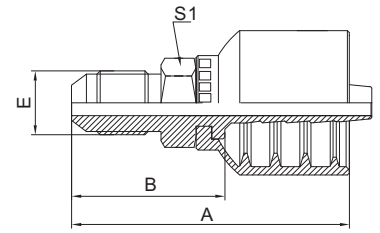

# TL-26711-PK

JIC. Female. 74° Cone seat. SAE J514

PART NO.	THREAD E	HOSE BORE		DIMENSIONS			
		DN	DASH	A	B	S1	S2
TL-26711-04-03PK	7/16"X20	5	03	38	19.4	14	14
TL-26711-04-04PK	7/16"X20	6	04	39	19.4	14	14
TL-26711-05-04PK	1/2"X20	6	04	40.5	20.9	14	17
TL-26711-05-05PK	1/2"X20	8	05	45.5	21	17	17
TL-26711-06-04PK	9/16"X18	6	04	41.5	21.9	14	19
TL-26711-06-05PK	9/16"X18	8	05	46	22.5	17	19
TL-26711-06-06PK	9/16"X18	10	06	45.5	23.5	17	19
TL-26711-06-08PK	9/16"X18	12	08	51.5	23	22	19
TL-26711-08-06PK	3/4"X16	10	06	46.5	24.5	19	24
TL-26711-08-08PK	3/4"X16	12	08	52.5	24	22	24
TL-26711-10-08PK	7/8"X14	12	08	55	26.5	22	27
TL-26711-10-10PK	7/8"X14	16	10	63	25.9	24	27
TL-26711-12-08PK	1.1/16"X12	12	08	55.5	27	27	32
TL-26711-12-10PK	1.1/16"X12	16	10	63.5	26.4	27	32
TL-26711-12-12PK	1.1/16"X12	20	12	66	26.4	27	32
TL-26711-16-16PK	1.5/16"X12	25	16	76	31	35	38
TL-26711-20-20PK	1.5/8"X12	32	20	84.3	37.3	47	50
TL-26711-24-24PK	1.7/8"X12	40	24	79	40.6	54	60
TL-26711-32-32PK	2.1/2"X12	50	32	95.5	48.3	64	73

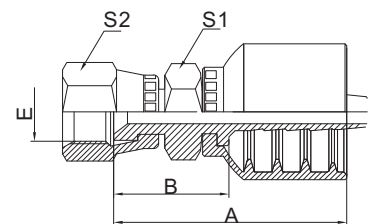



## TL-26741-PK

JIC. Female. Elbow 45°. 74° Cone seat. SAE J514

PART NO.	THREAD E	HOSE BORE		DIMENSIONS			
		DN	DASH	A	B	H	S1
TL-26741-04-04PK	7/16"X20	6	04	61.5	41.9	18.1	14
TL-26741-06-04PK	9/16"X18	10	06	70	48	20	19
TL-26741-08-06PK	3/4"X16	10	06	70	48	21	24
TL-26741-08-08PK	3/4"X16	12	08	88	59.5	23.5	24
TL-26741-10-10PK	7/8"X14	16	10	108	70.9	25	27
TL-26741-12-12PK	1.1/16"X12	20	12	118	78.4	30	32
TL-26741-16-16PK	1.5/16"X12	25	16	132.5	87.5	31.5	38
TL-26741-20-20PK	1.5/8"X12	32	20	145.8	98.8	37	50
TL-26741-24-24PK	1.7/8"X12	40	24	155	116.6	43	60
TL-26741-32-32PK	2.1/2"X12	50	32	184.5	137.3	51	73

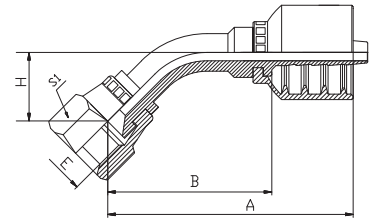

## TL-26791-PK

JIC. Female. Elbow 90°. 74° Cone seat. SAE J514

PART NO.	THREAD E	HOSE BORE		DIMENSIONS			
		DN	DASH	A	B	H	S1
TL-26791-04-04PK	7/16"X20	6	04	52.5	32.9	32.5	14
TL-26791-06-04PK	9/16"X18	6	04	52.5	32.9	33	19
TL-26791-06-06PK	9/16"X18	10	06	61	39	39	19
TL-26791-08-06PK	3/4"X16	10	06	61	39	40	24
TL-26791-08-08PK	3/4"X16	12	08	72.5	44	47	24
TL-26791-10-08PK	7/8"X14	12	08	72.5	44	48	27
TL-26791-10-10PK	7/8"X14	16	10	93	55.9	52.5	27
TL-26791-12-12PK	1.1/16"X12	20	12	103.5	63.9	63	32
TL-26791-16-16PK	1.5/16"X12	25	16	122	77	70	38
TL-26791-20-20PK	1.5/8"X12	32	20	137.8	90.8	84.5	50
TL-26791-24-24PK	1.7/8"X12	40	24	148	109.6	101.5	60
TL-26791-32-32PK	2.1/2"X12	50	32	178	130.8	122.5	73

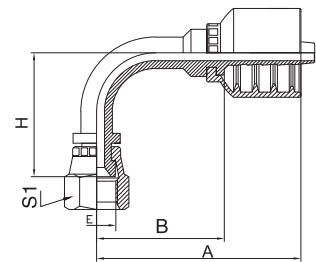

## INTERLOCK FITTINGS

### TL-13013-SP

BSPT. Male

PART NO.	THREAD E	HOSE BORE		DIMENSIONS		
		DN	DASH	A	C	S1
TL-13013-12-12SP	R3/4"X14	20	12	38	20	30
TL-13013-16-16SP	R1"X11	25	16	45.9	25.5	38
TL-13013-20-20SP	R1.1/4"X11	32	20	50	26.5	46
TL-13013-24-24SP	R1.1/2"X11	40	24	52.8	26.5	50
TL-13013-32-32SP	R2"X11	50	32	58.5	27.5	65

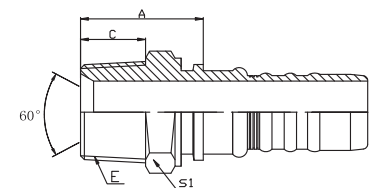

# TL-15613

NPT. Male

PART NO.	THREAD E	HOSE BORE		DIMENSIONS		
		DN	DASH	A	C	S1
TL-15613-12-12	Z3/4"X14	20	12	39.5	19.5	30
TL-15613-16-16	Z1"X11.5	25	16	47.8	25.5	38
TL-15613-20-20	Z1.1/4"X11.5	32	20	52	26.5	46
TL-15613-24-24	Z1.1/2"X11.5	40	24	54.3	27.5	50
TL-15613-32-32	Z2"X11.5	50	32	58.5	27.5	65

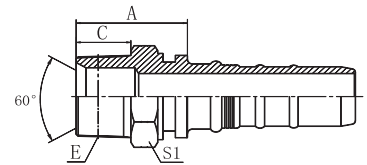

# TL-12613

BSP. Male. 60° Cone seat

PART NO.	THREAD E	HOSE BORE		DIMENSIONS		
		DN	DASH	A	C	S1
TL-12613-12-12	G3/4"X14	20	12	37.5	18.5	30
TL-12613-16-16	G1"X11	25	16	41	20.5	36
TL-12613-20-20	G1.1/4"X11	32	20	44	20.5	46
TL-12613-24-24	G1.1/2"X11	40	24	49.8	23	50
TL-12613-32-32	G2"X11	50	32	57.5	25.5	65

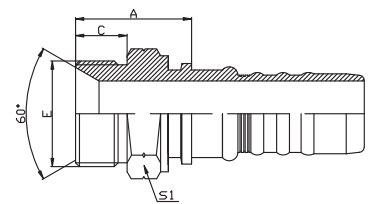

# TL-22613-W

BSP. Female. 60° Cone seat

PART NO.	THREAD E	HOSE BORE		DIMENSIONS		
		DN	DASH	A	C	S1
TL-22613-12-12W	G3/4"X14	20	12	25.5	11	32
TL-22613-16-16W	G1"X11	25	16	28.8	11.8	41
TL-22613-20-20W	G1.1/4"X11	32	20	32	10.8	50
TL-22613-24-24W	G1.1/2"X11	40	24	34.3	11.6	55
TL-22613-32-32W	G2"X11	50	32	36.5	16	70

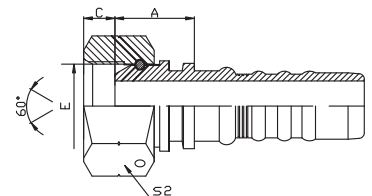

# TL-22613-ORW

BSP. Female. O-ring. 60° Cone seat

PART NO.	THREAD E	HOSE BORE		O-RING	DIMENSIONS		
		DN	DASH		A	C	S2
TL-22613-12-12ORW	G3/4"X14	20	12	O171	25.5	11	32
TL-22613-16-16ORW	G1"X11	25	16	O221	28.8	11.8	41
TL-22613-20-20ORW	G1.1/4"X11	32	20	O291	32	10.8	50
TL-22613-24-24ORW	G1.1/2"X11	40	24	O351	34.3	11.6	55

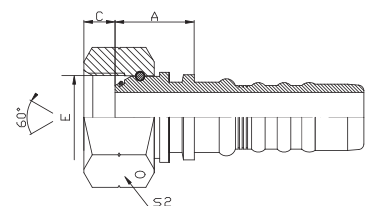

## TL-26713-W

JIC. Female. 74° Cone seat. SAE J514

PART NO.	THREAD E	HOSE BORE		DIMENSIONS		
		DN	DASH	A	C	S1
TL-26713-12-12W	1.1/16"X12	20	12	22.5	14.5	32
TL-26713-16-16W	1.5/16"X12	25	16	25.3	15.6	41
TL-26713-20-20W	1.5/8"X12	32	20	32.3	17	50
TL-26713-24-24W	1.7/8"X12	40	24	27.8	19.5	55
TL-26713-32-32W	2.1/2"X12	50	32	34.5	23.5	75

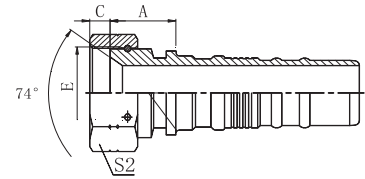

## TL-26793-W

JIC. Female. Elbow 90°. 74° Cone seat

PART NO.	THREAD E	HOSE BORE		DIMENSIONS			
		DN	DASH	A	C	H	S2
TL-26793-12-12W	1.1/16"X12	20	12	73.8	15	64.5	32
TL-26793-16-16W	1.5/16"X12	25	16	89.3	15.6	71	41
TL-26793-20-20W	1.5/8"X12	32	20	106	16.1	81.5	50
TL-26793-24-24W	1.7/8"X12	40	24	124.2	20	101	55
TL-26793-32-32W	2.1/2"X12	50	32	150.3	23.5	121.3	75

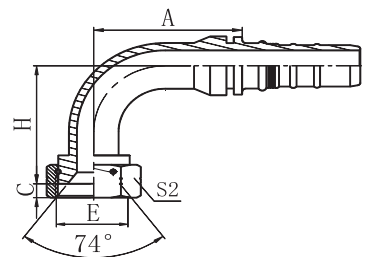

## TL-10513

Metric. Male. 24° Cone seat HT. ISO 8431-1 - DIN 3861

PART NO.	THREAD E	HOSE BORE		TUBE O.D.	DIMENSIONS		
		DN	DASH		A	C	S2
TL-10513-36-12	M36X2	20	12	25	43	20	38
TL-10513-42-16	M42X2	25	16	30	44.8	21	46
TL-10513-52-20	M52X2	32	20	38	49	22	55

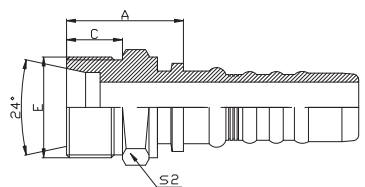

## TL-20513-W · TL-20513-T

Metric. Male. 24° Cone seat HT. ISO 12151-1 - DIN 3865

PART NO.	THREAD E	HOSE BORE		TUBE O.D.	O-RING	DIMENSIONS		
		DN	DASH			A	C	S2
TL-20513-30-12W	M30X2	20	12	20	O16.3X2.4	33	4	36
TL-20513-36-12T	M36X2	20	12	25	O20.3X2.4	38.5	3	41
TL-20513-36-16W	M36X2	25	16	25	O20.3X2.4	31.9	3	41
TL-20513-42-12T	M42X2	20	12	30	O25.3X2.4	42	5	50
TL-20513-42-16W	M42X2	25	16	30	O25.3X2.4	39.3	4	50
TL-20513-42-20W	M42X2	32	20	30	O25.3X2.4	38.8	5	50
TL-20513-52-20T	M52X2	32	20	38	O33.3X2.4	45	6.5	60
TL-20513-52-24W	M52X2	40	24	38	O33.3X2.4	38.2	6.5	60

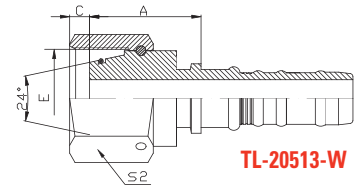

TL-20513-W

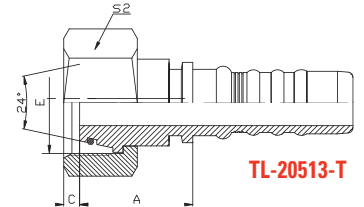

TL-20513-T

## TL-20543-W · TL-20543-T

Metric. Female. Elbow 45°. Male. 24° Cone seat HT. ISO 12151-1 - DIN 3865

PART NO.	THREAD E	HOSE BORE		TUBE O.D.	O-RING	DIMENSIONS			
		DN	DASH			A	C	H	S2
TL-20543-36-12T	M36X2	20	12	25	O20.3X2.4	89.5	3	33	41
TL-20543-42-12W	M42X2	25	16	30	O25.3X2.4	102.3	5	35.9	50
TL-20543-52-16T	M52X2	32	20	38	O33.3X2.4	114.5	6.5	39.4	60

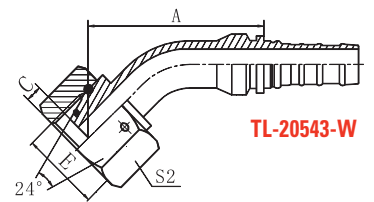

TL-20543-W

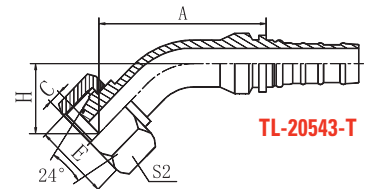

TL-20543-T

## TL-20593-W · TL-20593-T

Metric. Female. Elbow 90°. Male. 24° Cone seat HT. ISO 12151-1 - DIN 3865

PART NO.	THREAD E	HOSE BORE		TUBE O.D.	O-RING	DIMENSIONS			
		DN	DASH			A	C	H	S2
TL-20593-36-12T	M36X2	20	12	25	O20.3X2.4	75.5	3	67.8	46
TL-20593-36-16W	M36X2	25	16	25	O20.3X2.4	88.9	3.2	79.5	46
TL-20593-42-16W	M42X2	25	16	30	O25.3X2.4	88.9	5	80.5	50
TL-20593-42-20W	M42X2	32	20	30	O25.3X2.4	105.8	5	91.5	50
TL-20593-52-20T	M52X2	32	20	38	O33.3X2.4	106.5	6.5	86.5	60
TL-20593-52-24W	M52X2	40	24	38	O33.3X2.4	124.2	6.5	104.5	60

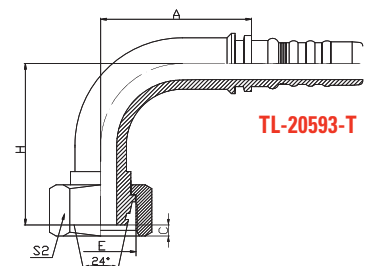

TL-20593-T

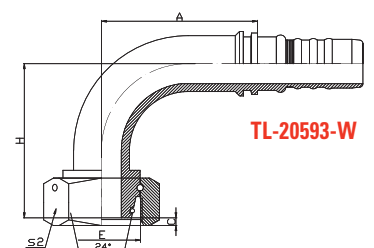

TL-20593-W

## TL-87313

SAE. Flange. 3000 Psi. Straight. ISO 12151-3 - SAE J516

PART NO.	FLANGE SIZE	HOSE BORE		DIMENSIONS			
		DN	DASH	A	C	D	L
TL-87313-12-12	3/4"	20	12	50	38.1	31.7	7
TL-87313-16-12	1"	20	12	58	44.4	38	8.2
TL-87313-16-16	1"	25	16	53.3	44.4	38	8.2
TL-87313-20-16	1.1/4"	25	16	59.3	50.8	43.2	8.2
TL-87313-20-20	1.1/4"	32	20	67	50.8	43.2	8.2
TL-87313-24-20	1.1/2"	32	20	72	60.3	50.3	8.2
TL-87313-24-24	1.1/2"	40	24	72.3	60.3	50.3	8.2
TL-87313-32-24	2"	40	24	74.3	71.4	62.2	9.8
TL-87313-32-32	2"	50	32	78.5	71.4	62.2	9.8

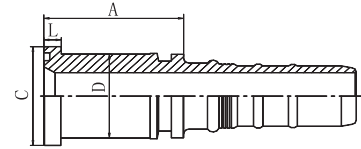

## TL-87343

SAE. Flange. 3000 Psi. Elbow 45°. ISO 12151-3 - SAE J516

PART NO.	FLANGE SIZE	HOSE BORE		DIMENSIONS				
		DN	DASH	A	C	D	H	L
TL-87343-12-12	3/4"	20	12	85.8	38.1	31.7	29	7
TL-87343-16-12	1"	20	12	85.5	44.4	38	30	8.2
TL-87343-16-16	1"	25	16	96.3	44.4	38	29.7	8.2
TL-87343-20-16	1.1/4"	25	16	96.3	50.8	43.2	29.7	8.2
TL-87343-20-20	1.1/4"	32	20	109	50.8	43.2	34	8.2
TL-87343-24-20	1.1/2"	32	20	110	60.3	50.3	35	8.2
TL-87343-24-24	1.1/2"	40	24	123.8	60.3	50.3	39	8.2
TL-87343-32-24	2"	40	24	123.8	71.4	62.2	39.1	9.8
TL-87343-32-32	2"	50	32	148.5	71.4	62.2	46.3	9.8

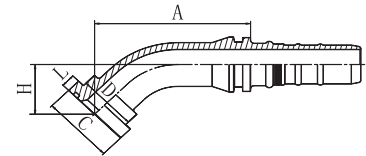

## TL-87393

SAE. Flange. 3000 Psi. Elbow 90°. ISO 12151-3 - SAE J516

PART NO.	FLANGE SIZE	HOSE BORE		DIMENSIONS				
		DN	DASH	A	C	D	H	L
TL-87393-12-12	3/4"	20	12	75	38.1	31.7	62	7
TL-87393-16-12	1"	20	12	59.5	44.4	38	62	8.2
TL-87393-16-16	1"	25	16	89.3	44.4	38	67.5	8.2
TL-87393-20-16	1.1/4"	25	16	88.3	50.8	43.2	67.5	8.2
TL-87393-20-20	1.1/4"	32	20	106	50.8	43.2	78.5	8.2
TL-87393-24-20	1.1/2"	32	20	106	60.3	50.3	80.5	8.2
TL-87393-24-24	1.1/2"	40	24	123.3	60.3	50.3	94	8.2
TL-87393-32-24	2"	40	24	123.3	71.4	62.2	94	9.8
TL-87393-32-32	2"	50	32	150.5	71.4	62.2	114.3	9.8

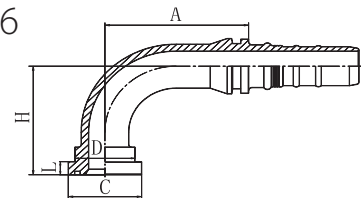

# TL-87613

SAE. Flange. 6000 Psi. ISO 12151-3 - SAE J516

PART NO.	FLANGE SIZE	HOSE BORE		DIMENSIONS			
		DN	DASH	A	C	D	L
TL-87613-12-12	3/4"	20	12	53.5	41.3	31.7	8.9
TL-87613-16-12	1"	20	12	57.5	47.6	38	9.6
TL-87613-16-16	1"	25	16	58.3	47.6	38	9.6
TL-87613-20-16	1.1/4"	25	16	67.3	54	43.6	10.4
TL-87613-20-20	1.1/4"	32	20	67	54	43.6	10.4
TL-87613-20-24	1.1/4"	40	24	74.7	54	43.6	10.4
TL-87613-24-20	1.1/2"	32	20	79	63.5	50.8	12.7
TL-87613-24-24	1.1/2"	40	24	78.8	63.5	50.8	12.7
TL-87613-32-24	2"	40	24	91.2	79.4	66.5	12.7
TL-87613-32-32	2"	50	32	91	79.4	66.5	12.7

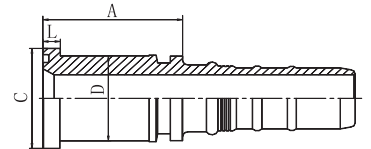

# TL-87643

SAE. Flange. 6000 Psi. Elbow 45°. ISO 12151-3 - SAE J516

PART NO.	FLANGE SIZE	HOSE BORE		DIMENSIONS				
		DN	DASH	A	C	D	H	L
TL-87643-12-12	3/4"	20	12	88.5	41.3	31.7	31.8	8.9
TL-87643-16-12	1"	20	12	90.5	47.6	38	33.2	9.6
TL-87643-16-16	1"	25	16	99.3	47.6	38	34.7	9.6
TL-87643-20-16	1.1/4"	25	16	104.3	54	43.6	37.5	10.4
TL-87643-20-20	1.1/4"	32	20	117	54	43.6	41.5	10.4
TL-87643-24-20	1.1/2"	32	20	120	63.5	50.8	45	12.7
TL-87643-24-24	1.1/2"	40	24	134.3	63.5	50.8	49	12.7
TL-87643-32-24	2"	40	24	140.2	79.4	66.5	54.7	12.7
TL-87643-32-32	2"	50	32	163.5	79.4	66.5	62	12.7

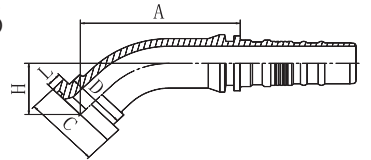

# TL-87693

SAE. Flange. 6000 Psi. Elbow 90°. ISO 12151-3 - SAE J516

PART NO.	FLANGE SIZE	HOSE BORE		DIMENSIONS				
		DN	DASH	A	C	D	H	L
TL-87693-12-12	3/4"	20	12	75.5	41.3	31.7	66	8.9
TL-87693-16-12	1"	20	12	75.5	47.6	38	68	9.6
TL-87693-16-16	1"	25	16	89.3	47.6	38	73.5	9.6
TL-87693-20-16	1.1/4"	25	16	89.3	54	43.6	78.5	10.4
TL-87693-20-20	1.1/4"	32	20	106	54	43.6	86.5	10.4
TL-87693-24-20	1.1/2"	32	20	106	63.5	50.8	89.5	12.7
TL-87693-24-24	1.1/2"	40	24	124.3	63.5	50.8	103	12.7
TL-87693-32-24	2"	40	24	124.3	79.4	66.5	103	12.7
TL-87693-32-32	2"	50	32	150.5	79.4	66.5	123.3	12.7

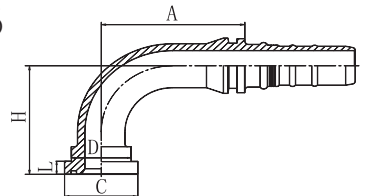

# TL-87913

SAE. Flange. 9000 Psi

PART NO.	FLANGE SIZE	HOSE BORE		DIMENSIONS			
		DN	DASH	A	C	D	L
TL-87913-12-12	3/4"	20	12	59	41.3	32	14.3
TL-87913-16-12	1"	20	12	63	47.6	38	14.3
TL-87913-16-16	1"	25	16	64.3	47.6	38	14.3
TL-87913-20-16	1.1/4"	25	16	67.3	54	44	14.3
TL-87913-20-20	1.1/4"	32	20	74	54	44	14.3
TL-87913-24-24	1.1/2"	32	20	80.8	63.5	51	14.3
TL-87913-24-20	1.1/2"	40	24	80.5	63.5	51	14.3

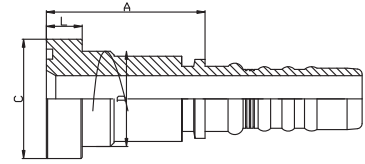

# TL-87943

SAE. Flange. 9000 Psi. Elbow 45°

PART NO.	FLANGE SIZE	HOSE BORE		DIMENSIONS				
		DN	DASH	A	C	D	H	L
TL-87943-12-12	3/4"	20	12	87.5	41.3	32	35.5	14.3
TL-87943-16-12	1"	20	12	87.5	47.6	38	36.5	14.3
TL-87943-16-16	1"	25	16	94.8	47.6	38	37.5	14.3
TL-87943-20-16	1.1/4"	25	16	104.3	54	44	38.5	14.3
TL-87943-20-20	1.1/4"	32	20	117	54	44	42	14.3
TL-87943-24-20	1.1/2"	32	20	117	63.5	51	43	14.3
TL-87943-24-24	1.1/2"	40	24	132.3	63.5	51	47	14.3

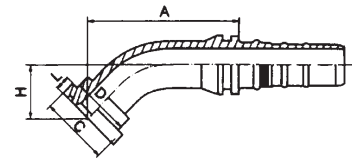

# TL-87993

SAE. Flange. 9000 Psi. Elbow 90°

PART NO.	FLANGE SIZE	HOSE BORE		DIMENSIONS				
		DN	DASH	A	C	D	H	L
TL-87993-12-12	3/4"	20	12	68.5	41.3	32	71.5	14.3
TL-87993-16-12	1"	20	12	68.5	47.6	38	72.5	14.3
TL-87993-16-16	1"	25	16	79.3	47.6	38	78.5	14.3
TL-87993-20-16	1.1/4"	25	16	79.3	54	44	79.5	14.3
TL-87993-20-20	1.1/4"	32	20	106	54	44	90.5	14.3
TL-87993-24-20	1.1/2"	32	20	106	63.5	51	92.5	14.3
TL-87993-24-24	1.1/2"	40	24	124.3	63.5	51	105	14.3

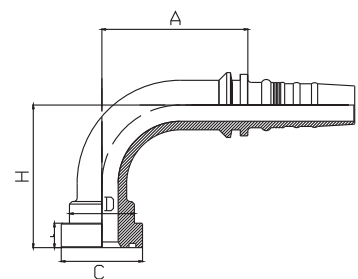

# TL-90013

Double connector

PART NO.	HOSE BORE		DIMENSIONS
	DN	DASH	
TL-90013-12	20	12	126
TL-90013-16	25	16	150
TL-90013-20	32	20	194
TL-90013-24	40	24	223
TL-90013-32	50	32	235

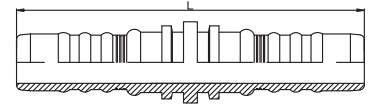

## REUSABLE FITTINGS

### TL-15618-R5

NPT. Male

PART NO.	THREAD E	HOSE BORE DASH	DIMENSIONS	
			A	S1
TL-15618-02-04(R5)	Z1/8"X27	04	42.8	12
TL-15618-04-04(R5)	Z1/4"X18	04	48.3	17
TL-1S618-04-06(R5)	Z1/4"X18	06	31	17
TL-15618-06-05(R5)	Z3/8"X18	05	32.9	19
TL-1S618-06-06(R5)	Z3/8"X18	06	50.7	19
TL-15618-08-08(R5)	Z1/2"X14	08	54.9	22
TL-15618-12-10(R5)	Z3/4"X14	10	42.5	30
TL-15618-12-12(R5)	Z3/4"X14	12	57	30
TL-15618-16-16(R5)	Z1"X11.5	16	70	36
TL-15618-20-20(R5)	Z1.1/4"X11.5	20	66	46
TL-1S618-24-24(R5)	Z1.1/2"X11.5	24	69	50
TL-1S618-32-32(R5)	Z2"X11.5	32	55	65

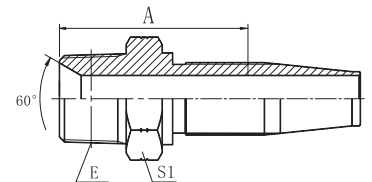

### TL-22618D

BSP. Female. 60° Cone seat

PART NO.	THREAD E	HOSE BORE DASH	DIMENSIONS			
			A	C	S1	S2
TL-22618D-04-04(R5)	G1/4"X19	04	42.3	5	14	19
TL-22618D-06-05(R5)	G3/8"X19	05	43.5	6.5	17	22
TL-22618D-06-06(R5)	G3/8"X19	06	45.7	6.5	17	22
TL-22618D-08-08(R5)	G1/2"X14	08	48.9	7.8	19	27
TL-22618D-10-10(R5)	G5/8"X14	10	45.5	9	22	30
TL-22618D-12-12(R5)	G3/4"X14	12	49	10.5	27	32
TL-22618D-16-16(R5)	G1"X11	16	57	11	32	41
TL-22618D-20-20(R5)W	G1.1/4"X11	20	56.5	11.5	41	50

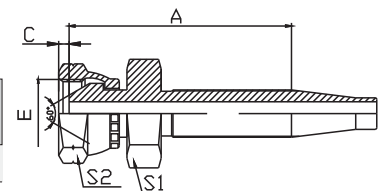



# TL-16718-R5

JIC. Male. 74° Cone seat. SAE J514

PART NO.	THREAD E	HOSE BORE DASH	DIMENSIONS	
			A	S1
TL-16718-04-04(R5)	7/16"X20	04	46.8	12
TL-16718-06-05(R5)	9/16"X18	05	31	17
TL-16718-06-06(R5)	9/16"X18	06	32	17
TL-16718-08-06(R5)	3/4"X16	06	34.7	22
TL-16718-08-08(R5)	3/4"X16	08	38	22
TL-16718-10-10(R5)	7/8"X14	10	40.5	24
TL-16718-12-12(R5)	1.1/16"X12	12	45.5	30
TL-16718-16-16(R5)	1.5/16"X12	16	44	36
TL-16718-20-20(R5)	1.5/8"X12	20	49.5	46
TL-16718-24-24(R5)	1.7/8"X12	24	52.5	50

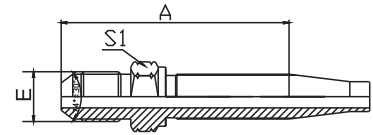

# TL-26718D-R5 · TL-26718D-R5W

JIC. Female. 74° Cone seat. SAE J514

PART NO.	THREAD E	HOSE BORE DASH	DIMENSIONS			
			A	C	S1	S2
TL-26718D-04-04(R5)	7/16"X20	04	39.8	8	14	17
TL-26718D-05-05(R5)	1/2"X20	05	25.4	9	14	17
TL-26718D-06-06(R5)	9/16"X18	06	41.7	9.5	17	19
TL-26718D-08-08(R5)	3/4"X16	08	44.4	10.8	22	24
TL-26718D-10-10(R5)	7/8"X14	10	42.5	12	27	27
TL-26718D-12-12(R5)	1.1/16"X12	12	46.5	15	32	32
TL-26718D-16-16(R5)	1.5/16"X12	16	33.5	14	38	41
TL-26718D-20-20(R5)	1.5/8"X12	20	52.5	15	41	50
TL-26718D-24-24(R5)	1.7/8"X12	24	43	19	46	55
TL-26718D-32-32(R5)	2.1/2"X12	32	45.5	23.5	65	75

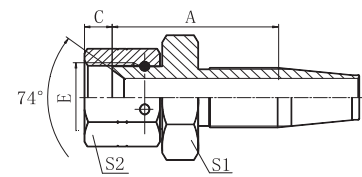
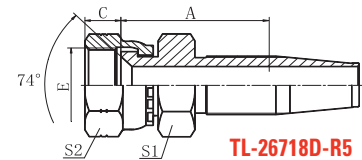

# TL-26798D-R5

JIC. Female. Elbow 90°. 74° Cone seat. SAE J514

PART NO.	THREAD E	HOSE BORE DASH	DIMENSIONS				
			A	C	H	S1	S2
TL-26798D-04-04(R5)	7/16"X20	04	52.8	8	33.5	14	15
TL-26798D-05-05(R5)	1/2"X20	05	43.4	9	37	14	17
TL-26798D-06-06(R5)	9/16"X18	06	59.5	9.5	39	17	19
TL-26798D-08-08(R5)	3/4"X16	08	53	10.8	47.5	19	24
TL-26798D-10-10(R5)	7/8"X14	10	77.5	12	52.5	24	27
TL-26798D-12-12(R5)	1.1/16"X12	12	79.5	15	63.5	27	32
TL-26798D-16-16(R5)	1.5/16"X12	16	86.5	14	70	32	41
TL-26798D-20-20(R5)	1.5/8"X12	20	100.5	15	85	38	50
TL-26798D-24-24(R5)	1.7/8"X12	24	121	19	97.5	46	55
TL-26798D-32-32(R5)	2.1/2"X12	32	143.3	23.5	118.8	60	75

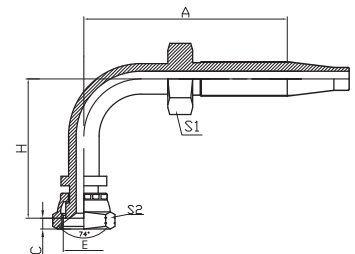

# LOW PRESSURE EASY LOCK FITTINGS

## TL-13011-SP

BSPT. Male

PART NO.	THREAD E	HOSE BORE		DIMENSIONS		
		DN	DASH	A	C	S1
TL-13011-02-04SP(PO)	R1/8"X28	6	04	17.7	10	12
TL-13011-04-04SP(PO)	R1/4"X19	6	04	22.3	14	14
TL-13011-04-06SP(PO)	R1/4"X19	10	06	22	14.5	17
TL-13011-06-06SP(PO)	R3/8"X19	10	06	24	15	19
TL-13011-08-08SP(PO)	R1/2"X14	12	08	30.5	20	22
TL-13011-12-12SP(PO)	R3/4"X14	20	12	29.6	20	27

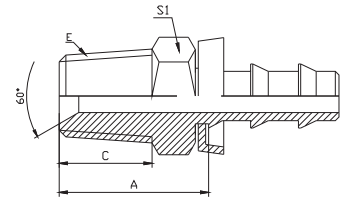

## TL-15611-PO

NPT. Male

PART NO.	THREAD E	HOSE BORE		DIMENSIONS		
		DN	DASH	A	C	S1
TL-15611-02-04PO	Z1/8"X27	6	04	18.2	10.5	12
TL-15611-04-04PO	Z1/4"X18	6	04	22.3	15	14
TL-15611-04-06PO	Z1/4"X18	10	06	22.5	15	14
TL-15611-06-06PO	Z3/8"X18	10	06	26	16	19
TL-15611-06-08PO	Z3/8"X18	12	08	23.7	16	19
TL-15611-08-08PO	Z1/2"X14	12	08	30.5	19.5	22
TL-15611-08-10PO	Z1/2"X14	16	10	29	19.5	22
TL-15611-12-12PO	Z3/4"X14	20	12	31.5	19.5	27

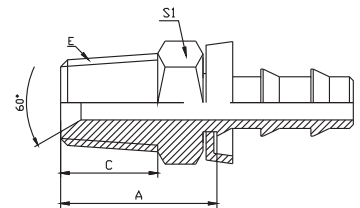

## TL-12611-PO

BSP. Male. 60° Cone seat

PART NO.	THREAD E	HOSE BORE		DIMENSIONS		
		DN	DASH	A	C	S1
TL-12611-04-04PO	G1/4"X19	6	04	21.8	12	14
TL-12611-06-06PO	G3/8"X19	10	06	25.6	13.5	17
TL-12611-08-08PO	G1/2"X14	12	08	28	16	22
TL-12611-10-10PO	G5/8"X14	16	10	30	17.5	24
TL-12611-12-12PO	G3/4"X14	20	12	32.5	18.5	27

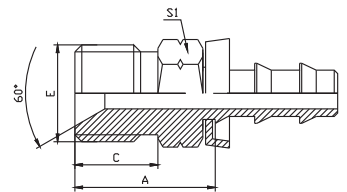

# TL-22611-P0

BSP. Female. 60° Cone seat

PART NO.	THREAD E	HOSE BORE		DIMENSIONS		
		DN	DASH	A	C	S2
TL-22611-04-04PO	G1/4"X19	6	04	15.8	5	19
TL-22611-06-06PO	G3/8"X19	10	06	18.6	6.5	22
TL-22611-08-08PO	G1/2"X14	12	08	19.5	7.8	27
TL-22611-12-12PO	G3/4"X14	20	12	19.5	10.5	32

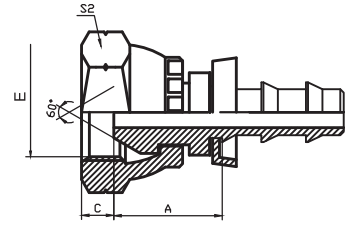

# TL-22691K-P0

BSP. Compact Female. Elbow 90°. 60° Cone seat

PART NO.	THREAD E	HOSE BORE		DIMENSIONS				
		DN	DASH	A	C	H	S1	S2
TL-22691K-04-04PO	G1/4"X19	6	04	14.3	5	18.5	11	19
TL-22691K-04-06PO	G3/8"X19	10	06	18.1	6.5	24	16	22
TL-22691K-08-08PO	G1/2"X14	12	08	20.5	7.8	28.5	19	27
TL-22691K-12-12PO	G3/4"X14	20	12	23.5	10.5	33	27	32

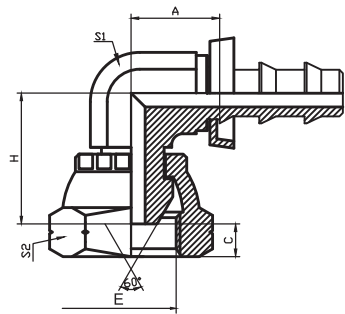

# TL-16711-P0

JIC. Male. 74° Cone seat. SAE J514

PART NO.	THREAD E	HOSE BORE		DIMENSIONS		
		DN	DASH	A	C	S1
TL-16711-04-04PO	7/16"X20	6	04	23.8	14	12
TL-16711-06-04PO	9/16"X18	6	04	23.8	14	17
TL-16711-06-06PO	9/16"X18	10	06	24.6	14	17
TL-16711-08-06PO	3/4"X16	10	06	29.6	16.7	22
TL-16711-08-08PO	3/4"X16	12	08	29	16.7	22
TL-16711-10-10PO	7/8"X14	16	10	32	19.5	24
TL-16711-10-12PO	7/8"X14	20	12	32	19.5	24
TL-16711-12-08PO	1.1/16"X12	12	08	36	22	27
TL-16711-12-10PO	1.1/16"X12	16	10	36	22	27
TL-16711-12-12PO	1.1/16"X12	20	12	36	22	27

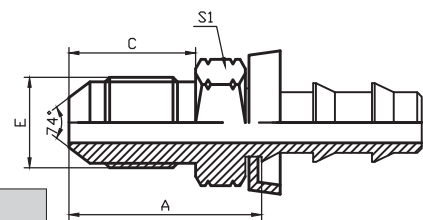

## TL-26711-PO

JIC. Female. 74° Cone seat. SAE J514

PART NO.	THREAD E	HOSE BORE		DIMENSIONS		
		DN	DASH	A	C	S2
TL-26711-04-04PO	7/16"X20	6	04	12.3	8	17
TL-26711-05-04PO	1/2"X20	6	04	12.2	9	17
TL-26711-06-06PO	9/16"X18	10	06	14.5	9.5	19
TL-26711-08-06PO	3/4"X16	10	06	12.5	10.8	24
TL-26711-08-08PO	3/4"X16	12	08	15.5	10.8	24
TL-26711-10-08PO	7/8"X14	12	08	15.2	12	27
TL-26711-10-10PO	7/8"X14	16	10	16.6	12	27
TL-26711-12-12PO	1.1/16"X12	20	12	17.5	15	32
TL-26711-16-16PO	1.5/16"X12	25	16	18.6	14	41

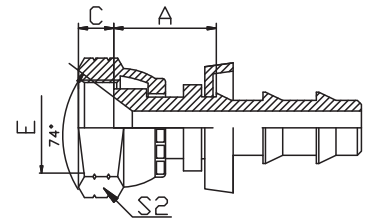

## TL-26791K-PO

JIC. Compact Female. Elbow 90°. 74° Cone seat. SAE J514

PART NO.	THREAD E	HOSE BORE		DIMENSIONS				
		DN	DASH	A	C	H	S1	S2
TL-26791K-04-04PO	7/16"X20	6	04	11.7	8	18	11	17
TL-26791K-06-04PO	9/16"X18	6	04	16.3	9.5	21	14	19
TL-26791K-06-06PO	9/16"X18	10	06	18.1	9.5	21	16	19
TL-26791K-08-06PO	3/4"X16	10	06	21.1	10.8	25	19	24
TL-26791K-08-08PO	3/4"X16	12	08	20.5	10.8	25	19	24
TL-26791K-10-10PO	7/8"X14	16	10	18.5	12	27.5	22	27
TL-26791K-12-12PO	1.1/16"X12	20	12	23.5	15	30	27	32

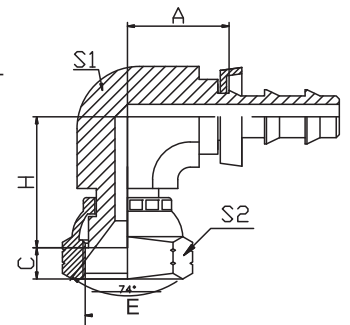

## TL-27811-PO

JIC. Female. B31390° Cone seat. SAE J513

PART NO.	THREAD E	HOSE BORE		DIMENSIONS		
		DN	DASH	A	C	S2
TL-27811-04-04PO	7/16"X20	6	04	12.8	8	17
TL-27811-05-04PO	1/2"X20	6	04	13.7	9.5	17
TL-27811-06-04PO	5/8"X18	6	04	13.7	11	22
TL-27811-06-06PO	5/8"X18	10	06	15.6	11	22
TL-27811-08-06PO	3/4"X16	10	06	15.5	10.8	24
TL-27811-08-08PO	3/4"X16	12	08	15.5	10.8	24
TL-27811-10-08PO	7/8"X14	12	08	15.2	12	27
TL-27811-12-12PO	1.1/16"X12	20	12	17.5	13	32

