



Quick release couplings



BASICS ON QUICK RELEASE COUPLINGS

Hydraulic

Composed of two bodies, the female or socket and the male or plug. When connected by pushing the two parts the valves open and the flow starts and contain the internal pressure and the forces that pull the joint apart. Known as well as push & pull type.

To disconnect the joint it has to be pulled ejecting the plug and the valves shut off.

We offer different types of couplings of steel, stainless steel and brass.

General purpose. Ball lock

It is the most common design. A group of balls are placed in holes which are located all along the inner crown diameter of the socket. The holes are tapered so that to prevent the balls do not fall into the cavity occupied by the plug when disconnected.

A spring-loaded sleeve around the socket outer crown diameter pushes the balls onto the socket body internal crown diameter. While connecting the plug, the sleeve is pushed back, making a clearance thus the balls can move outwards.

The plug once connected, the sleeve pushes the balls against the groove of the plug. When disconnecting, by sliding the sleeve back push the balls out making a clearance so the plug can be removed.

This range of couplings is the most common, thus we present it as a general purpose quick release couplings double shut off, poppet or ball valves. We offer two families of general purpose, namely, meeting the dimensional requirements of ISO 7241-1 one of them and the other ISO 5675.

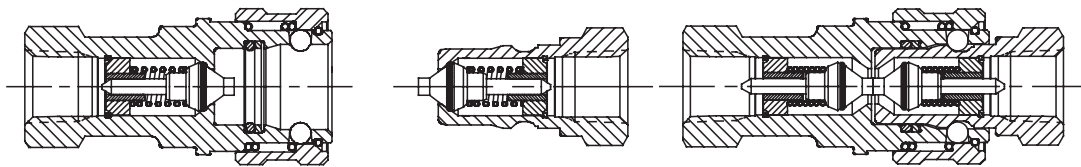

Flat face

It is used in cases where the spill has to be limited to a minimum. This system is clean and minimizes the contamination.

The system uses a poppet-style shut off valve on the socket and on the plug. The flat face can be easily cleaned and reduces the pressure drop as well the air inclusion as compared with the ball lock. Known as well as No spill couplings.

This range dimensionally meets the ISO 16028

Thread lock

Designed and used for extreme high pressure applications. It can be connected under full system pressure by rotating the female, ductile cast iron wing nut or steel hex nut onto the mating threaded plug. Ball or poppet valve options.

This type provides a minimum air inclusion during connection and minimum spill during disconnection. Available with steel hex nut or ductile wing nut to withstand hammerblows associated with connection and disconnection under pressure.

Indicated in applications on dump trailers, mobile drilling rigs, mining equipment, large mobile equipment, salt spreaders and chemical transfer units.

Free flow

Used in applications where the maximum flow is needed. Known as well as non-valve coupling. The fact that there are not valves inside minimizes the pressure drop.

Accessories

Protective dust caps and dust plugs are available in rubber or metal in a variety of sizes. They should be used whenever possible to help reduce contamination of the hydraulic system and improve service life of the socket and the plug.

Seal kits are available for the sockets and the plug, also poppet assemblies for different couplings. Break away clamps and reducers are as well available.

Pneumatic quick coupling basics

Pneumatic quick couplers, are used for pneumatic applications, connecting air tools, hoses, or other implements to compressed air supplies. They may be used also with other gases.

Quick release couplings are composed of two halves, the female coupler and the male nipple. The female coupler may have a male pipe threaded end, a female pipe threaded end or a hose barb end, so the nipple, which may have a pipe threaded end a female threaded end or a hose barb end.

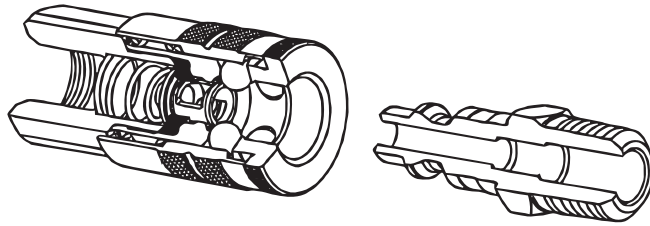

It is important to pay a close attention when disconnecting the coupling under pressure as the pressure provoke a hose whip which may produce injuries and damages.

The coupler half contains a shut-off valve that is automatically opened when a mating nipple is inserted and automatically closes when the nipple is removed.

To connect pneumatic quick couplings, the coupler sleeve has to be pulled back, insert the nipple, and release the sleeve. To disconnect the other way round it has to be done, pull the sleeve back to release the nipple.

Our program of pneumatic quick couplings is developed to be interchangeable with the most popular designs of this industry which have come to be recognized as Standard.

General purpose. Single shut off couplings

Series TL300, DN 5.5. Diameter 5,5 mm (7/32").
Flow capacity 1.050 l/min (37,1 cfm). Working pressure 16 bar (232 psi). Under ARO 210 Standard. Interchange with Parker 50, Rectus 22KA, CEJN 300 Series. Zinc plated steel/brass.

Series TL310, DN 5.3. Diameter 5,3 mm (7/32").
Flow capacity 1.050 l/min (37,1 cfm). Working pressure 16 bar (232 psi). Under ISO 6150B Standard. Interchange with Parker 20, Rectus 23KA, Hansen 3000, CEJN 300 series. Zinc plated steel/brass.

Series TL315, DN 7.5. Diameter 7,5 mm (5/16").
Flow capacity 1.950 l/min (68,8 cfm). Under Japanese Standard. Interchange with Nitto HI-CUPLA, CEJN 315, Rectus 13 KA Series. Zinc plated steel/brass.

Series TL320, DN 7.6. Diameter 7,6 mm (5/16").
Flow capacity 2.250 l/min (79,5 cfm). Under European Standard. Interchange with CEJN 320, Rectus 25 KA & 26 KA Series. Zinc plated steel/brass.

Series TL430, DN 8.2. Diameter 8,2 mm (5/16").
Flow capacity 2.500 l/min (88,3 cfm). Under ISO 6150B Standard. Interchange with CEJN 430 Series. Zinc plated steel/brass.

Series TL550. DN11. Diameter 11 mm (7/16").
Flow capacity 4.050 l/min (143 cfm). Under ISO 6150B Standard. Interchange with CEJN 550 Series. Zinc plated steel/brass.

Series TL-17. DN 4.6. Diameter 4,6 mm (0,2").
Twist lock. Interchange with Rectus 17KA, Schrader 5. Brass.

Series TL-19. DN 4.8. Diameter 4,8 mm (0,2").
Interchange with Rectus 19KA PCL 60. Brass.

Series TL-23. DN 5.2. Diameter 5,2 mm (0,22").
ISO 6150B. Interchange with Rectus 23KA, Parker 20, Hansen 3000, CEJN 310 Series. Brass.

Series TL-25. DN 7.5. Diameter 7,5 mm (0,29").
Interchange with European CEJN 320, Rectus 25KA & 26KA Series. Brass.

Series TL-26. DN 7.8. Diameter 7,8 mm (0,29").
Interchange with European CEJN 320, Rectus 25 & 26KA Series. Brass.

Series TL-DG. DN Plug bore 0,22".
Interchange with CEJN 320, Rectus 25 & 26KA Series. Brass.

Series TL-LAM. DN Plug bore 0,22".
Interchange with Parker 20, Rectus 23KA, Hansen 3000 Series. Brass.

Series TL-LAO. DN Plug bore 0,22".
Interchange with Parker 50, Rectus 22KA, CEJN 300 Series.

HYDRAULIC GENERAL PURPOSE. BALL LOCK. ISO 7241

TL-S1

ISO 7241-A. Steel. Socket BSPP-NPT. Plug BSPP-NPT

APPLICATIONS

The TL-S1 Series brings to the industry a proven design for use on construction equipment, forestry equipment, agricultural machinery, oil tools, oil equipment steel mill machinery, and other demanding hydraulic applications.



SPECIFICATIONS

BODY SIZE (in)	RATED PRESSURE (PSI)	RATED FLOW (GPM)	TEMPERATURE RANGE (std seals)	STANDARD SEAL MATERIAL
1/4	5000	3	-20°C to +120°C	NBR
3/8	4000	6		
1/2	4000	12		
3/4	3000	28		
1	3000	50		
1-1/4	3000	88		
1-1/2	2000	220		
2	2000	240		

FEATURES

- Poppet valves available to prevent uncoupled leakage.
- Poppet valves open automatically when coupled, within rated working pressure, to keep the flow expeditely.
- Critical parts are hardened for durability.
- Dependable ball-locking mechanism holds the mating halves together.
- Socket and plug are precision machined from solid bar stock.
- TL-S1 series conforms to the standard of ISO 7241-A.
- Compatible with PARKER 6600 Series, FASTER ANV Series, AEROQUIP 5600 Series and HANSEN HA 15000 Series.

PERFORMANCE:

TL-S1 Series (1/4", 3/8", 1/2", 3/4", 1")
(Test fluid: Oil-200SUS)

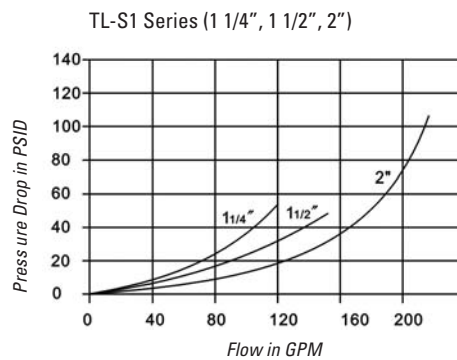
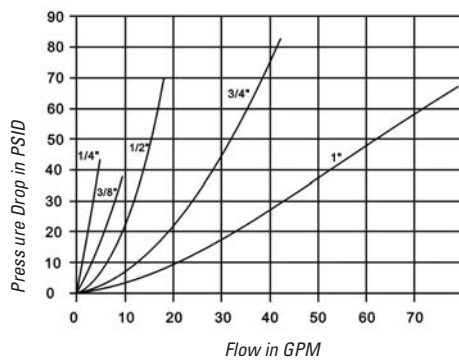

1 GPM= 3.78 L/Min 1PSID= 0.0069 MPa

BODY SIZE	PART NO.	LS	φD	¹ / ₈	A	T	
6.3	TL-S1-02SF	50	26	19	13	G1/4	NPT1/4
10	TL-S1-03SF	56	31.5	22	14	G3/8	NPT3/8
12.5	TL-S1-04SF	66	38.5	27	16	G1/2	NPT1/2
20	TL-S1-06SF	80	48	34	18	G3/4	NPT3/4
25	TL-S1-08SF	94	56	41	21	G1	NPT1
31.5	TL-S1-10SF	117	69.5	50	25	G1-1/4	NPT1-1/4
40	TL-S1-12SF	133	84	60	27	G1-1/2	NPT1-1/2
50	TL-S1-16SF	165	99	75	26	G2	NPT2

(SOCKET)

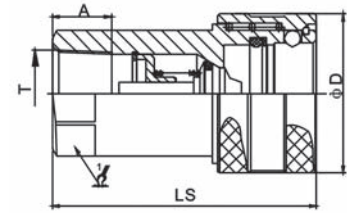

BODY SIZE	PART NO.	LP	d	C	² / ₈	A	T	
6.3	TL-S1-02PF	35.5	11.8	15	19	13	G1/4	NPT1/4
10	TL-S1-03PF	36.5	17.3	21.4	22	14	G3/8	NPT3/8
12.5	TL-S1-04PF	43.5	20.5	27	27	16	G1/2	NPT1/2
20	TL-S1-06PF	57	29	28	35	18	G3/4	NPT3/4
25	TL-S1-08PF	59.5	34.3	36	41	21	G1	NPT1
31.5	TL-S1-10PF	75	45	46	50	25	G1-1/4	NPT1-1/4
40	TL-S1-12PF	83.5	55	52	60	27	G1-1/2	NPT1-1/2
50	TL-S1-16PF	105	65	64	75	26	G2	NPT2

(PLUG)

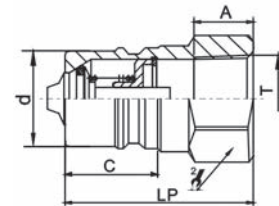

BODY SIZE	PART NO.	L	φD	¹ / ₈	² / ₈	T	
6.3	TL-S1-02	71	26	19	19	G1/4	NPT1/4
10	TL-S1-03	75	31.5	22	22	G3/8	NPT3/8
12.5	TL-S1-04	88	38.5	27	27	G1/2	NPT1/2
20	TL-S1-06	110	48	34	35	G3/4	NPT3/4
25	TL-S1-08	119.5	56	41	41	G1	NPT1
31.5	TL-S1-10	150	69.5	50	50	G1-1/4	NPT1-1/4
40	TL-S1-12	167.5	84	60	60	G1-1/2	NPT1-1/2
50	TL-S1-16	210.5	99	75	75	G2	NPT2

COUPLING FITTING

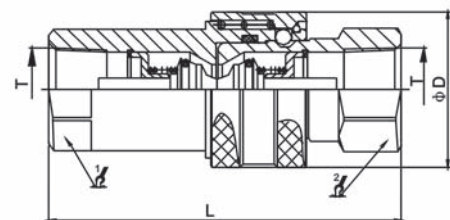

TL-S1-SS

ISO 7241-A. Stainless Steel AISI 316. Socket BSPP-NPT. Plug BSPP-NPT

APPLICATIONS

The TL-S1-SS Series brings to the industry a proven design for use on construction equipment, forestry equipment, agricultural machinery, oil tools, oil equipment steel mill machinery, and other demanding hydraulic applications.



SPECIFICATIONS

BODY SIZE (in)	RATED PRESSURE (PSI)	RATED FLOW (GPM)	TEMPERATURE RANGE (std seals)	STANDARD SEAL MATERIAL
1/4	2000	3	-20°C to +200°C	VITON
3/8	2000	6		
1/2	1500	12		
3/4	1500	28		
1	1000	50		
1-1/4	1000	88		
1-1/2	1000	220		
2	1000	240		

FEATURES

- Poppet valves available to prevent uncoupled leakage.
- Poppet valves open automatically when coupled, within rated working pressure, to keep the flow expeditely.
- Dependable ball-locking mechanism holds the mating halves together.
- Socket and plug are precision machined from solid bar stock.
- TL-S1-SS series conforms to the standard of ISO 7241-A.
- Compatible with PARKER 6600 Series, FASTER ANV Series, AEROQUIP 5600 Series and HANSEN HA 15000 Series.

PERFORMANCE:

TL-S1-SS Series (1/4", 3/8", 1/2", 3/4", 1")
(Test fluid: Oil-200SUS)

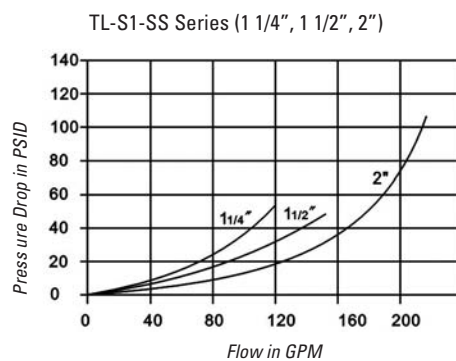
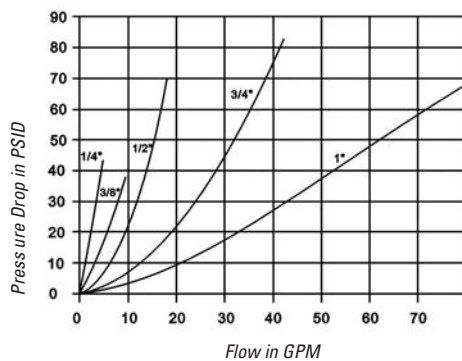

1 GPM= 3.78 L/Min 1PSID= 0.0069 MPa

BODY SIZE	PART NO.	LS	φD	$\frac{1}{2}$	A	T	
6.3	TL-S1-SS-02SF	50	26	19	13	G1/4	NPT1/4
10	TL-S1-SS-03SF	56	31.5	22	14	G3/8	NPT3/8
12.5	TL-S1-SS-04SF	66	38.5	27	16	G1/2	NPT1/2
20	TL-S1-SS-06SF	80	48	34	18	G3/4	NPT3/4
25	TL-S1-SS-08SF	94	56	41	21	G1	NPT1
31.5	TL-S1-SS-10SF	117	69.5	50	25	G1-1/4	NPT1-1/4
40	TL-S1-SS-12SF	133	84	60	27	G1-1/2	NPT1-1/2
50	TL-S1-SS-16SF	165	99	75	29	G2	NPT2

(SOCKET)

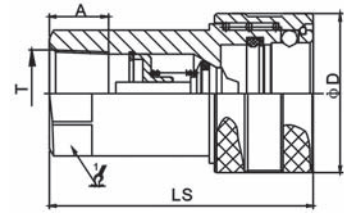

BODY SIZE	PART NO.	LP	d	C	$\frac{2}{2}$	A	T	
6.3	TL-S1-SS-02PF	35.5	11.8	15	19	13	G1/4	NPT1/4
10	TL-S1-SS-03PF	36.5	17.3	21.4	22	14	G3/8	NPT3/8
12.5	TL-S1-SS-04PF	43.5	20.5	27	27	16	G1/2	NPT1/2
20	TL-S1-SS-06PF	57	29	28	35	18	G3/4	NPT3/4
25	TL-S1-SS-08PF	59.5	34.3	36	41	21	G1	NPT1
31.5	TL-S1-SS-10PF	75	45	46	50	25	G1-1/4	NPT1-1/4
40	TL-S1-SS-12PF	83.5	55	52	60	27	G1-1/2	NPT1-1/2
50	TL-S1-SS-16PF	105	65	64	75	29	G2	NPT2

(PLUG)

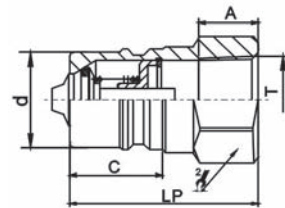

BODY SIZE	PART NO.	L	φD	$\frac{1}{2}$	$\frac{2}{2}$	T	
6.3	TL-S1-SS-02	71	26	19	19	G1/4	NPT1/4
10	TL-S1-SS-03	75	31.5	22	22	G3/8	NPT3/8
12.5	TL-S1-SS-04	88	38.5	27	27	G1/2	NPT1/2
20	TL-S1-SS-06	110	48	34	35	G3/4	NPT3/4
25	TL-S1-SS-08	119.5	56	41	41	G1	NPT1
31.5	TL-S1-SS-10	150	69.5	50	50	G1-1/4	NPT1-1/4
40	TL-S1-SS-12	167.5	84	60	60	G1-1/2	NPT1-1/2
50	TL-S1-SS-16	210.5	99	75	75	G2	NPT2

COUPLING FITTING

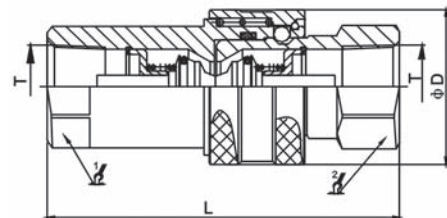

TL-S2

ISO 7241-B. Steel. Socket BSPP-NPT. Plug BSPP-NPT

APPLICATIONS

TL-S2 couplings, are used across the spectrum of hydraulic applications. These Double Shut-Off couplings can be found anywhere that fluid transfer lines need to be connected and disconnected for operation or maintenance of equipment, and a loss of fluid is undesirable.

TL-S2 are used in construction equipment, forestry equipment, agricultural machinery, oil tools, oil equipment, steel mill machinery, and other demanding hydraulic applications.



SPECIFICATIONS

BODY SIZE (in)	RATED PRESSURE (PSI)	RATED FLOW (GPM)	TEMPERATURE RANGE (std seals)	STANDARD SEAL MATERIAL
1/8	5000	1	-20°C to +120°C	NBR
1/4	5000	3		
3/8	4000	6		
1/2	4000	12		
3/4	3000	28		
1	3000	50		

FEATURES

- Poppet valves available to prevent uncoupled leakage.
- Poppet valves open automatically when coupled, within rated working pressure, to keep the flow expeditely.
- Critical parts are hardened for durability.
- Dependable ball-locking mechanism holds the mating halves together.
- Socket and plug are precision machined from solid bar stock.
- TL-S2 series conforms to the standard of ISO 7241-B.
- Compatible with PARKER 60 Series, FASTER HNV Series, AEROQUIP FD45 Series and HANSEN HK Series.

PERFORMANCE:

TL-S2 Series (1/4", 3/8", 1/2", 3/4", 1")
(Test fluid: Oil-200SUS)

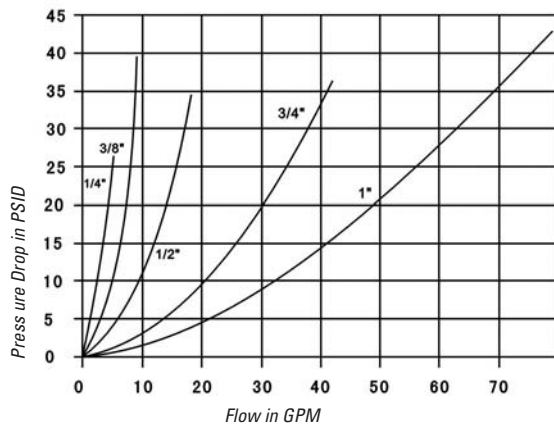

1 GPM= 3.78 L/Min 1PSID= 0.0069 MPa

BODY SIZE	PART NO.	LS	φD	¹ / ₈	A	T
5	TL-S2-01SF	48	24	17	9.5	G1/8 NPT1/8
6.3	TL-S2-02SF	58	28.5	19	13	G1/4 NPT1/4
10	TL-S2-03SF	65	35	24	13	G3/8 NPT3/8
12.5	TL-S2-04SF	74	44.5	28.5	20.5	G1/2 NPT1/2
20	TL-S2-06SF	92	54	36	22	G3/4 NPT3/4
25	TL-S2-08SF	103	63.5	41	23	G1 NPT1

(SOCKET)

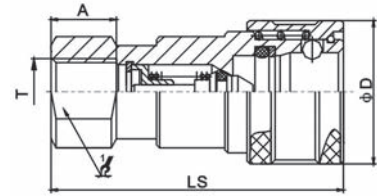

BODY SIZE	PART NO.	LP	d	C	² / ₈	A	T
5	TL-S2-01PF	29	10.8	19	14	9.5	G1/8 NPT1/8
6.3	TL-S2-02PF	36	14.2	22.8	19	13	G1/4 NPT1/4
10	TL-S2-03PF	40	19	25	24	13	G3/8 NPT3/8
12.5	TL-S2-04PF	46.5	23.5	28	28.5	20.5	G1/2 NPT1/2
20	TL-S2-06PF	56	31.5	36	36	22	G3/4 NPT3/4
25	TL-S2-08PF	63	37.8	45	41	23	G1 NPT1

(PLUG)

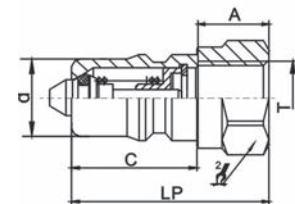

BODY SIZE	PART NO.	L	φD	¹ / ₈	² / ₈	T
5	TL-S2-01	58.5	24	17	17	G1/8 NPT1/8
6.3	TL-S2-02	72	28.5	19	19	G1/4 NPT1/4
10	TL-S2-03	80.5	35	24	24	G3/8 NPT3/8
12.5	TL-S2-04	93.5	44.5	28.5	28.5	G1/2 NPT1/2
20	TL-S2-06	112.5	54	36	36	G3/4 NPT3/4
25	TL-S2-08	126.5	63.5	41	41	G1 NPT1

COUPLING FITTING

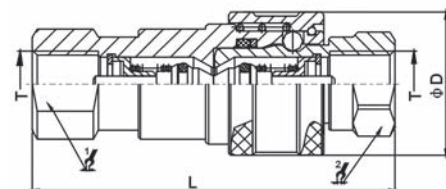

TL-S2-SS

ISO 7241-B. Stainless Steel AISI 316. Socket BSPP-NPT. Plug BSPP-NPT

APPLICATIONS

TL-S2-SS are used in construction equipment, hydraulic applications. These Double Shut-Off couplings can be found anywhere that fluid transfer lines need to be connected and disconnected for operation or maintenance of equipment, and a loss of fluid is undesirable.

TL-S2-SS are used in construction equipment, forestry equipment, agricultural machinery, oil tools, oil equipment, steel mill machinery, and other demanding hydraulic applications.



SPECIFICATIONS

BODY SIZE (in)	RATED PRESSURE (PSI)	RATED FLOW (GPM)	TEMPERATURE RANGE (std seals)	STANDARD SEAL MATERIAL
1/8	2000	1	-20°C to +180°C	VITON
1/4	2000	3		
3/8	2000	6		
1/2	1500	12		
3/4	1500	28		
1	1000	50		

FEATURES

- Poppet valves available to prevent uncoupled leakage.
- Poppet valves open automatically when coupled, within rated working pressure, to keep the flow expeditely.
- Dependable ball-locking mechanism holds the mating halves together.
- Socket and plug are precision machined from solid bar stock.
- TL-S2-SS series conforms to the standard of ISO 7241-B.
- Compatible with PARKER 60 Series, FASTER HNV Series, AEROQUIP FD45 Series and HANSEN HK Series.

PERFORMANCE:

TL-S2-SS Series (1/4", 3/8", 1/2", 3/4", 1")
(Test fluid: Oil-200SUS)

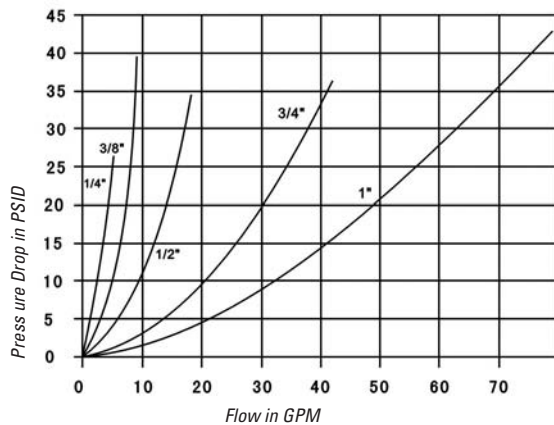

1 GPM= 3.78 L/Min 1PSID= 0.0069 MPa

BODY SIZE	PART NO.	LS	ϕD	$^1 \text{A}$	A	T
5	TL-S2-SS-01SF	50	24	17	10	G1/8 NPT1/8
6.3	TL-S2-SS-02SF	58	28.5	19	13	G1/4 NPT1/4
10	TL-S2-SS-03SF	65	35	24	13	G3/8 NPT3/8
12.5	TL-S2-SS-04SF	73.4	42	30	17	G1/2 NPT1/2
20	TL-S2-SS-06SF	92	54	36	22	G3/4 NPT3/4
25	TL-S2-SS-08SF	103	65	41	23	G1 NPT1

(SOCKET)

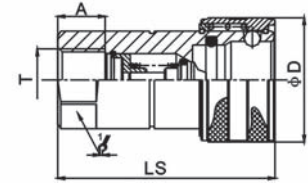

BODY SIZE	PART NO.	LP	d	C	$^2 \text{A}$	A	T
5	TL-S2-SS-01PF	31	10.8	19	14	10	G1/8 NPT1/8
6.3	TL-S2-SS-02PF	36	14.2	22.8	19	13	G1/4 NPT1/4
10	TL-S2-SS-03PF	40	19	25	24	13	G3/8 NPT3/8
12.5	TL-S2-SS-04PF	45.5	23.5	28	27	17	G1/2 NPT1/2
20	TL-S2-SS-06PF	56	31.5	36	36	22	G3/4 NPT3/4
25	TL-S2-SS-08PF	63	37.8	35.5	45	23	G1 NPT1

(PLUG)

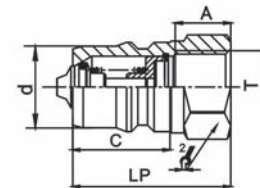

BODY SIZE	PART NO.	L	ϕD	$^1 \text{A}$	$^2 \text{A}$	T
5	TL-S2-SS-01	62.5	24	17	17	G1/8 NPT1/8
6.3	TL-S2-SS-02	72.2	27	19	19	G1/4 NPT1/4
10	TL-S2-SS-03	80.5	35	24	24	G3/8 NPT3/8
12.5	TL-S2-SS-04	91.5	42	30	27	G1/2 NPT1/2
20	TL-S2-SS-06	112.5	54	36	36	G3/4 NPT3/4
25	TL-S2-SS-08	126.5	63.5	41	41	G1 NPT1

COUPLING FITTING

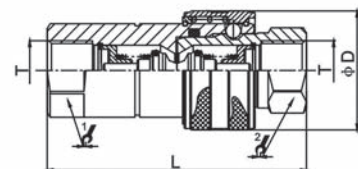

TL-KZD

ISO 7241-B. Brass. Socket BSPP-NPT. Plug BSPP-NPT

APPLICATIONS

TL-KZD couplings, are used across the spectrum of hydraulic applications. These Double Shut-Off couplings can be found anywhere that fluid transfer lines need to be connected and disconnected for operation or maintenance of equipment, and a loss of fluid is undesirable. Primarily used with hydraulic fluid.

TL-KZD couplings are also used with chemicals, water, steam and some gases.



SPECIFICATIONS

BODY SIZE (in)	RATED PRESSURE (PSI)	RATED FLOW (GPM)	TEMPERATURE RANGE (std seals)	STANDARD SEAL MATERIAL
1/8	1000	1		
1/4	1000	3		
3/8	1000	6		
1/2	1000	12		
3/4	1000	28	-20°C to +120°C	NBR
1	1000	50		
1 1/4	800	75		
1 1/2	800	100		
2	800	150		

FEATURES

- Poppet valves available to prevent uncoupled leakage.
- Poppet valves open automatically when coupled, within rated working pressure, to keep the flow expeditely.
- Dependable ball-locking mechanism holds the mating halves together.
- Socket and plug are precision machined from solid bar stock.
- TL-KZD series conforms to the standard of ISO 7241-B.
- Compatible with PARKER 60 Series, FASTER HNV Series, AEROQUIP FD45 Series and HANSEN HK Series.

PERFORMANCE:

TL-KZD Series (1/8", 1/4", 3/8", 1/2")
(Test fluid: Oil-150SUS)

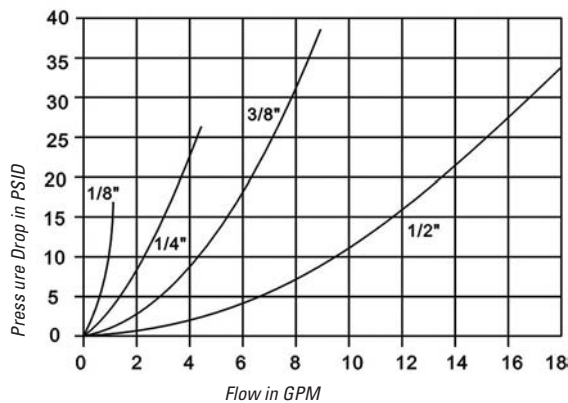

1 GPM= 3.78 L/Min 1PSID= 0.0069 MPa

PERFORMANCE:

TL-KZD Series (3/4", 1", 1 1/4", 1 1/2", 2")
(Test fluid: Oil-200SUS)

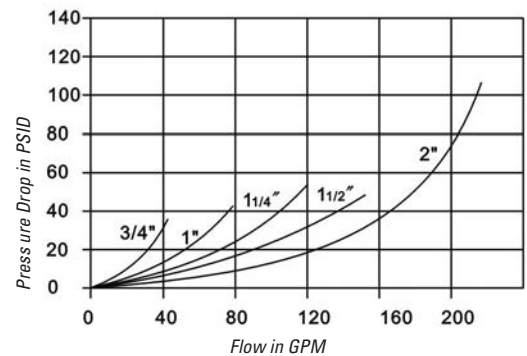

BODY SIZE	PART NO.	LS	φD	¹ / ₂	A	T
5	TL-KZD-01SF	48	24	14	8	G1/8
6.3	TL-KZD-02SF	58	27	19	12.5	ZG1/4
10	TL-KZD-03SF	65	35	22	13	ZG3/8
12.5	TL-KZD-04SF	72.5	45	29	14	ZG1/2
20	TL-KZD-06SF	88	54	36	17	ZG3/4
25	TL-KZD-08SF	102	64.5	41	23	ZG1
31.5	TL-KZD-10SF	115	69	54	27	ZG1-1/4
40	TL-KZD-12SF	124	79	60	27	ZG1-1/2
50	TL-KZD-16SF	132	102	77	30	ZG2

Note: Only size 01 to 08 conform to the stand of ISO 7241-B

(SOCKET)

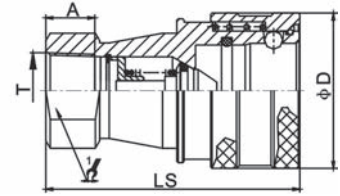

BODY SIZE	PART NO.	LP	d	C	² / ₂	A	T
5	TL-KZD-01PF	29	10.8	19	14	8	G1/8
6.3	TL-KZD-02PF	36	14.2	22.5	17	12.5	ZG1/4
10	TL-KZD-03PF	40	19	25	22	13	ZG3/8
12.5	TL-KZD-04PF	44	23.5	28	27	14	ZG1/2
20	TL-KZD-06PF	52	31.4	36	36	17	ZG3/4
25	TL-KZD-08PF	62	37.8	40	41	23	ZG1
31.5	TL-KZD-10PF	70	45	45	52	27	ZG1-1/4
40	TL-KZD-12PF	75	50	49	60	27	ZG1-1/2
50	TL-KZD-16PF	80	70	52	77	30	ZG2

Note: Only size 01 to 08 conform to the stand of ISO 7241-B

(PLUG)

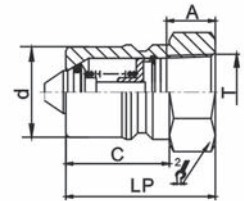

COUPLING FITTING

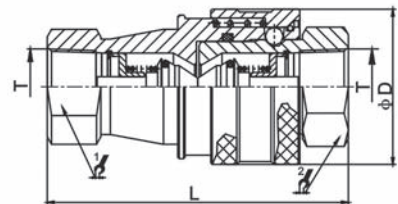

BODY SIZE	PART NO.	L	φD	¹ / ₂	² / ₂	T
5	TL-KZD-01	58.5	24	14	14	G1/8
6.3	TL-KZD-02	72.5	28	19	17	ZG1/4
10	TL-KZD-03	80.5	35	22	22	ZG3/8
12.5	TL-KZD-04	89	45	29	27	ZG1/2
20	TL-KZD-06	105	54	36	36	ZG3/4
25	TL-KZD-08	124.5	64.5	41	41	ZG1
31.5	TL-KZD-10	140.5	69	54	52	ZG1-1/4
40	TL-KZD-12	150.5	79	60	60	ZG1-1/2
50	TL-KZD-16	160.5	102	77	77	ZG2

Note: Only size 01 to 08 conform to the stand of ISO 7241-B

TL-KZF

ISO 7241-B. Stainless steel AISI 304. Socket BSPP-NPT. Plug BSPP-NPT

APPLICATIONS

TL-KZF couplings, are used across the spectrum of hydraulic applications. These Double Shut-Off couplings can be found anywhere that fluid transfer lines need to be connected and disconnected for operation or maintenance of equipment, and a loss of fluid is undesirable. Primarily used with hydraulic fluid.

TL-KZF couplings are also used with chemicals, water, steam and some gases.



SPECIFICATIONS

BODY SIZE (in)	RATED PRESSURE (PSI)	RATED FLOW (GPM)	TEMPERATURE RANGE (std seals)	STANDARD SEAL MATERIAL
1/8	2000	1		
1/4	2000	3		
3/8	1500	6		
1/2	1500	12		
3/4	1500	28	-20°C to +180°C	VITON
1	1000	50		
1 1/4	1000	75		
1 1/2	1000	100		
2	1000	150		

FEATURES

- Poppet valves available to prevent uncoupled leakage.
- Poppet valves open automatically when coupled, within rated working pressure, to keep the flow expeditely.
- Dependable ball-locking mechanism holds the mating halves together.
- Socket and plug are precision machined from solid bar stock.
- TL-KZF series conforms to the standard of ISO 7241-B.
- Compatible with PARKER 60 Series, FASTER HNV Series, AEROQUIP FD45 Series and HANSEN HK Series.

PERFORMANCE:

TL-KZF Series (1/8", 1/4", 3/8", 1/2")
(Test fluid: Oil-150SUS)

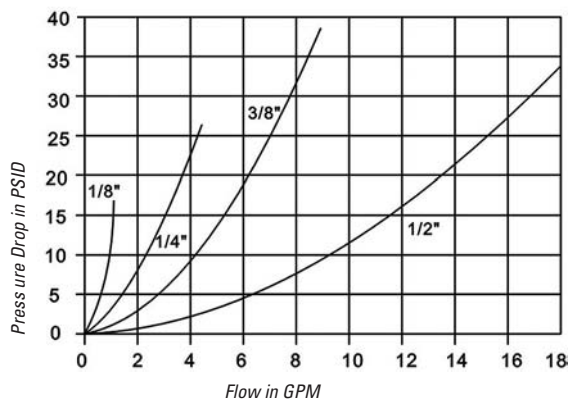

1 GPM= 3.78 L/Min 1PSID= 0.0069 MPa

PERFORMANCE:

TL-KZF Series (3/4", 1", 1 1/4", 1 1/2", 2")
(3/4" & 1": Test fluid: Oil-150SUS)
(1 1/4" & 1 1/2", 2": Test fluid: Oil-200SUS)

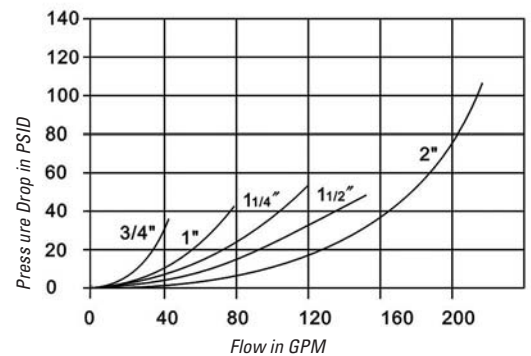

BODY SIZE	PART NO.	LS	φD	¹ / ₈	A	T
5	TL-KZF-01SF	48	24	14	8	G1/8
6.3	TL-KZF-02SF	58	27	19	12.5	ZG1/4
10	TL-KZF-03SF	65	35	22	13	ZG3/8
12.5	TL-KZF-04SF	72.5	45	29	14	ZG1/2
20	TL-KZF-06SF	88	54	36	17	ZG3/4
25	TL-KZF-08SF	102	64.5	41	23	ZG1
31.5	TL-KZF-10SF	115	69	54	27	ZG1-1/4
40	TL-KZF-12SF	124	79	60	27	ZG1-1/2
50	TL-KZF-16SF	132	102	77	30	ZG2

Note: Only size 01 to 08 conform to the stand of ISO 7241-B

(SOCKET)

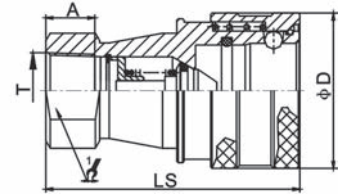

BODY SIZE	PART NO.	LP	d	C	² / ₈	A	T
5	TL-KZF-01PF	29	10.8	19	14	8	G1/8
6.3	TL-KZF-02PF	36	14.2	22.5	17	12.5	ZG1/4
10	TL-KZF-03PF	40	19	25	22	13	ZG3/8
12.5	TL-KZF-04PF	44	23.5	28	27	14	ZG1/2
20	TL-KZF-06PF	52	31.4	36	36	17	ZG3/4
25	TL-KZF-08PF	62	37.8	40	41	23	ZG1
31.5	TL-KZF-10PF	70	45	45	52	27	ZG1-1/4
40	TL-KZF-12PF	75	50	49	60	27	ZG1-1/2
50	TL-KZF-16PF	80	70	52	77	30	ZG2

Note: Only size 01 to 08 conform to the stand of ISO 7241-B

(PLUG)

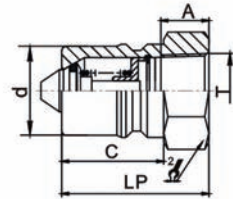

COUPLING FITTING

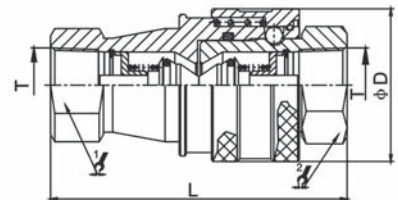

BODY SIZE	PART NO.	L	φD	¹ / ₈	² / ₈	T
5	TL-KZF-01	58.5	24	14	14	G1/8
6.3	TL-KZF-02	72.5	28	19	17	ZG1/4
10	TL-KZF-03	80.5	35	22	22	ZG3/8
12.5	TL-KZF-04	89	45	29	27	ZG1/2
20	TL-KZF-06	105	54	36	36	ZG3/4
25	TL-KZF-08	124.5	64.5	41	41	ZG1
31.5	TL-KZF-10	140.5	69	54	52	ZG1-1/4
40	TL-KZF-12	150.5	79	60	60	ZG1-1/2
50	TL-KZF-16	160.5	102	77	77	ZG2

Note: Only size 01 to 08 conform to the stand of ISO 7241-B

HYDRAULIC GENERAL PURPOSE. BALL LOCK. ISO 5675

TL-S5 · TL-S5C

APPLICATIONS

The TL-S5 and TL-S5C Series brings to the industry a proven design for use on construction equipment, forestry equipment agricultural machinery, and oil tools.

SPECIFICATIONS

BODY SIZE (in)	RATED PRESSURE (PSI)	RATED FLOW (GPM)	TEMPERATURE RANGE (std seals)	STANDARD SEAL MATERIAL
1/2	3000	12	-20°C to +120°C	NBR



FEATURES

- Double acting sleeve for one handed push-to-connect operation when coupler is clamp or bulkhead mounted.
- Poppet valves available to prevent uncoupled leakage.
- Poppet valves open automatically when coupled, within rated working pressure, to keep the flow expediently.
- Critical parts are hardened for durability.
- Dependable ball-locking mechanism holds the mating halves together.
- Socket and plug are precision machined from solid bar stock.
- TL-S5 series conforms to the standard of ISO 5675.
- Compatible with PARKER 4250 Series, FASTER CPV-CNV Series.

PERFORMANCE:

TL-S5 Series (1/2")
(Test fluid: Oil-200SUS)

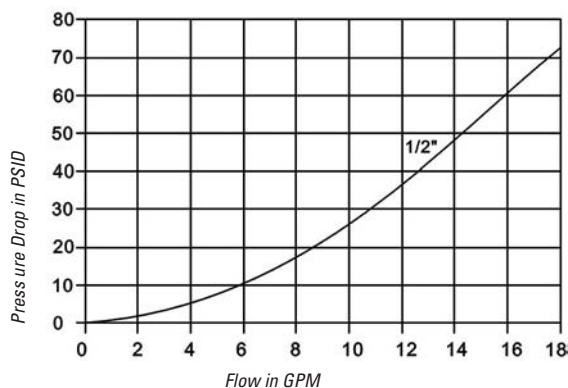

1 GPM= 3.78 L/Min 1PSID= 0.0069 MPa

(SOCKET)

BODY SIZE	PART NO.	LS	ΦD	$\frac{1}{2}$	$\frac{3}{4}$	T	
12.5	TL-S5-04SF3/8	66	38	27		3/8BSP	NPT3/8
12.5	TL-S5-04SF1/2	66	38	27		1/2BSP	NPT1/2
12.5	TL-S5-04SF3/4	69	38	34		3/4BSP	NPT3/4
12.5	TL-S5-04SFM14	66	38	27		M14*1.5	-
12.5	TL-S5-04SFM16	66	38	27		M16*1.5	-
12.5	TL-S5-04SFM18	66	38	27		M18*1.5	-
12.5	TL-S5-04SFM22	66	38	27		M22*1.5	-

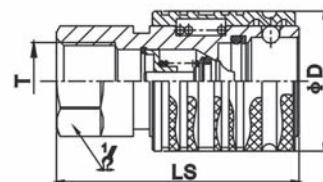
**(PLUG)**

BODY SIZE	PART NO.	LP	d	C	$\frac{1}{2}$	$\frac{3}{4}$	T	
12.5	TL-S5-04PF3/8	61.5	20.5	27	27		3/8BSP	NPT3/8
12.5	TL-S5-04PF1/2	44	20.5	27	27		1/2BSP	NPT1/2
12.5	TL-S5-04PF3/4	64.5	20.5	34	34		3/4BSP	NPT3/4
12.5	TL-S5-04PFM14	61.5	20.5	27	27		M14*1.5	-
12.5	TL-S5-04PFM 16	61.5	20.5	27	27		M16*1.5	-
12.5	TL-S5-04PFM18	61.5	20.5	27	27		M18*1.5	-
12.5	TL-S5-04PFM22	44	20.5	27	27		M22*1.5	-

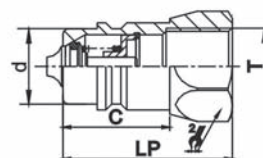
**COUPLING FITTING**

BODY SIZE	PART NO.	L	ΦD	$\frac{1}{2}$	$\frac{3}{4}$	T	
12.5	TL-S5-04F3/8	105.5	38	27	27	3/8BSP	NPT3/8
12.5	TL-S5-04F1/2	105.5	38	27	27	1/2BSP	NPT1/2
12.5	TL-S5-04F3/4	105.5	38	34	34	3/4BSP	NPT3/4
12.5	TL-S5-04FM14	105.5	38	27	27	M14*1.5	-
12.5	TL-S5-04FM16	105.5	38	27	27	M16*1.5	-
12.5	TL-S5-04FM18	105.5	38	27	27	M18*1.5	-
12.5	TL-S5-04FM22	105.5	38	27	27	M22*1.5	-

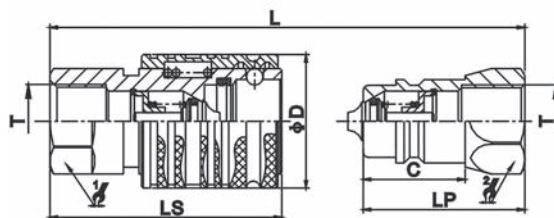

TL-S5

ISO 5675. Steel. Socket BSPP-Metric-NPT.
Plug BSPP-Metric-NPT

(SOCKET)

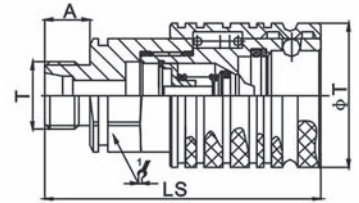

BODY SIZE	PART NO.	LS	ΦD	¹ ∠	A	T
12.5	TL-S5-04SM8L	73.5	38	27	12	M14*1.5
12.5	TL-S5-04SM10L	73.5	38	27	12	M16*1.5
12.5	TL-S5-04SM12L	73.5	38	27	12	M18*1.5
12.5	TL-S5-04SM15L	75.5	38	27	14	M22*1.5
12.5	TL-S5-04SM18L	75.5	38	27	14	M26*1.5
12.5	TL-S5-04SM10S	73.5	38	27	12	M18*1.5
12.5	TL-S5-04SM12S	73.5	38	27	12	M20*1.5
12.5	TL-S5-04SM14S	75.5	38	27	14	M22*1.5
12.5	TL-S5-04SM16S	75.5	38	27	14	M24*1.5
12.5	TL-S5-04SM20S	77.5	38	30	16	M30*2

(PLUG)

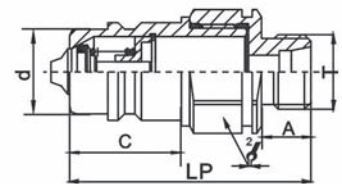

BODY SIZE	PART NO.	LP	d	C	² ∠	A	T
12.5	TL-S5-04PM8L	58.5	20.5	27	27	12	M14*1.5
12.5	TL-S5-04PM10L	58.5	20.5	27	27	12	M16*1.5
12.5	TL-S5-04PM12L	58.5	20.5	27	27	12	M18*1.5
12.5	TL-S5-04PM15L	60.5	20.5	27	27	14	M22*1.5
12.5	TL-S5-04PM18L	60.5	20.5	27	27	14	M26*1.5
12.5	TL-S5-04PM10S	58.5	20.5	27	27	12	M18*1.5
12.5	TL-S5-04PM12S	58.5	20.5	27	27	12	M20*1.5
12.5	TL-S5-04PM14S	60.5	20.5	27	27	14	M22*1.5
12.5	TL-S5-04PM16S	60.5	20.5	27	27	14	M24*1.5
12.5	TL-S5-04PM20S	62.5	20.5	27	30	16	M30*2

COUPLING FITTING

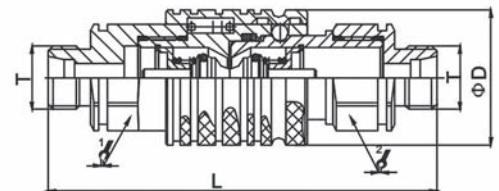

BODY SIZE	PART NO.	L	ΦD	¹ ∠	² ∠	T
12.5	TL-S5-04-8L	109.5	38	27	27	M14*1.5
12.5	TL-S5-04-10L	109.5	38	27	27	M16*1.5
12.5	TL-S5-04-12L	109.5	38	27	27	M18*1.5
12.5	TL-S5-04-15L	113.5	38	27	27	M22*1.5
12.5	TL-S5-04-18L	113.5	38	27	27	M26*1.5
12.5	TL-S5-04-10S	109.5	38	27	27	M18*1.5
12.5	TL-S5-04-12S	109.5	38	27	27	M20*1.5
12.5	TL-S5-04-14S	113.5	38	27	27	M22*1.5
12.5	TL-S5-04-16S	113.5	38	27	27	M24*1.5
12.5	TL-S5-04-20S	113.5	38	30	30	M30*2

TL-S5C

ISO 5675. Steel. Bulkhead Socket BSPP-Metric-NPT.
Plug BSPP-Metric-NPT

(SOCKET)

BODY SIZE	PART NO.	LS	ΦD	¹ /	² /	T
12.5	TL-S5C-04SM8L	87	38	27	19	M14*1.5
12.5	TL-S5C-04SM10L	87	38	27	24	M16*1.5
12.5	TL-S5C-04SM12L	87	38	27	24	M18*1.5
12.5	TL-S5C-04SM15L	89	38	27	27	M22*1.5
12.5	TL-S5C-04SM18L	89	38	27	30	M26*1.5
12.5	TL-S5C-04SM10S	87	38	27	24	M18*1.5
12.5	TL-S5C-04SM12S	87	38	27	27	M20*1.5
12.5	TL-S5C-04SM14S	89	38	27	27	M22*1.5
12.5	TL-S5C-04SM16S	89	38	27	30	M24*1.5
12.5	TL-S5C-04SM20S	96	38	30	36	M30*2

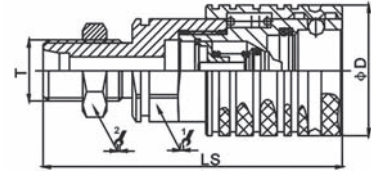

(PLUG)

BODY SIZE	PART NO.	LP	d	C	² /	³ /	T
12.5	TL-S5C-04PM8L	72	20.5	27	19	27	M14*1.5
12.5	TL-S5C-04PM10L	72	20.5	27	24	27	M16*1.5
12.5	TL-S5C-04PM12L	72	20.5	27	24	27	M18*1.5
12.5	TL-S5C-04PM15L	74	20.5	27	27	27	M22*1.5
12.5	TL-S5C-04PM18L	74	20.5	27	30	27	M26*1.5
12.5	TL-S5C-04PM10S	72	20.5	27	24	27	M18*1.5
12.5	TL-S5C-04PM12S	72	20.5	27	27	27	M20*1.5
12.5	TL-S5C-04PM14S	74	20.5	27	27	27	M22*1.5
12.5	TL-S5C-04PM16S	74	20.5	27	30	27	M24*1.5
12.5	TL-S5C-04PM20S	81	20.5	27	36	30	M30*2

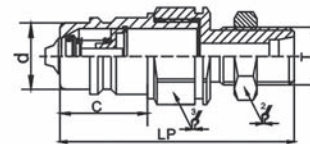

COUPLING FITTING

BODY SIZE	PART NO.	L	ΦD	¹ /	² /	³ /	T
12.5	TL-S5C-04-8L	137.5	38	27	19	27	M14*1.5
12.5	TL-S5C-04-10L	137.5	38	27	24	27	M16*1.5
12.5	TL-S5C-04-12L	137.5	38	27	24	27	M18*1.5
12.5	TL-S5C-04-15L	143.5	38	27	27	27	M22*1.5
12.5	TL-S5C-04-18L	143.5	38	27	30	27	M26*1.5
12.5	TL-S5C-04-10S	137.5	38	27	24	27	M18*1.5
12.5	TL-S5C-04-12S	137.5	38	27	27	27	M20*1.5
12.5	TL-S5C-04-14S	137.5	38	27	27	27	M22*1.5
12.5	TL-S5C-04-16S	143.5	38	27	30	27	M24*1.5
12.5	TL-S5C-04-20S	145.5	38	30	36	30	M30*2

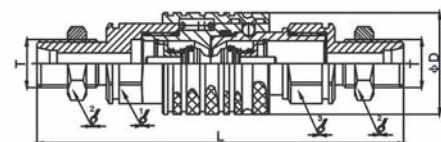

TL-S4

ISO 5675. Steel. Socket BSPP-NPT. Plug BSPP-NPT

APPLICATIONS

The TL-S4 Series brings to the industry a proven design for use on construction equipment, forestry equipment, agricultural machinery, oil tools, steel mill machinery, and other demanding hydraulic applications.



SPECIFICATIONS

BODY SIZE (in)	RATED PRESSURE (PSI)	RATED FLOW (GPM)	TEMPERATURE RANGE (std seals)	STANDARD SEAL MATERIAL
1/4	5000	3		
3/8	4000	6		
1/2	4000	12	-20°C to +120°C	NBR
3/4	3000	28		
1	3000	50		

FEATURES

- Poppet valves available to prevent uncoupled leakage.
- Ball valves available for rugged dependability in heavy-duty hydraulic applications within rated working pressure.
- Hard, chrome alloy balls are used for valving. It be loaded on the valve seat by the springs.
- The valve provides a metal-to-metal seal between the ball and coined seat.
- Critical parts are hardened for durability.
- Dependable ball-locking mechanism holds the mating halves together.
- Socket and plug are precision machined from solid bar stock.
- TL-S4 series conforms to the standard of ISO 5675.
- Compatible with PARKER 4000 Series and FASTER NV/NS Series.

PERFORMANCE:

TL-S4 (1/4", 3/8", 1/2", 3/4", 1")
(Test fluid: Oil-200SUS)

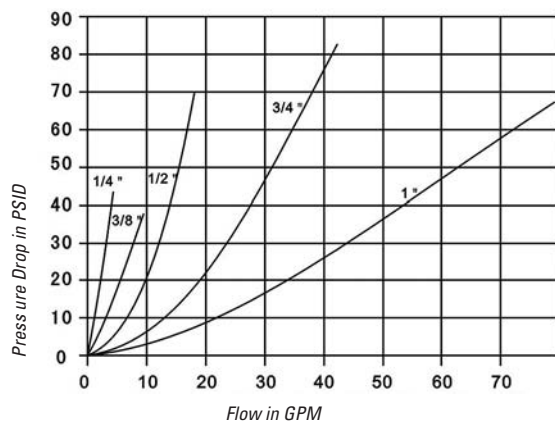

1 GPM= 3.78 L/Min 1PSID= 0.0069 MPa

BODY SIZE	PART NO.	LS	φD	¹ / ₄	A	T
6.3	TL-S4-02SF	53.5	27.6	19	12.5	G1/4 NPT1/4
10	TL-S4-03SF	63	34	24	13	G3/8 NPT3/8
12.5	TL-S4-04SF	66.3	38.6	27	16	G1/2 NPT1/2
*	20 TL-S4-06SF	82.5	48.2	34	19	G3/4 NPT3/4
*	20 TL-S4-06SF (E)	83.5	47.5	35	18	G3/4 NPT3/4
25	TL-S4-08SF	96.5	56	41	21	G1 NPT1

* Note: TL-S4-06SF, Faster interchange
TL-S4-06SF (E), Parker interchange

(SOCKET)

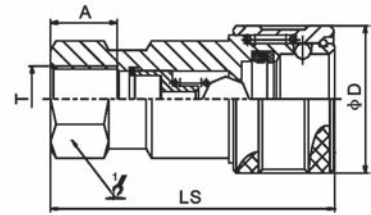

BODY SIZE	PART NO.	LP	d	C	² / ₄	A	T
6.3	TL-S4-02PF	36	14.2	18.5	19	12.5	G1/4 NPT1/4
10	TL-S4-03PF	40	19	22	24	13	G3/8 NPT3/8
12.5	TL-S4-04PF	43.5	20.5	27	27	16	G1/2 NPT1/2
*	20 TL-S4-06PF	53.5	28	32	34	19	G3/4 NPT3/4
*	20 TL-S4-06PF (E)	51	26.9	28.5	33.3	18	G3/4 NPT3/4
25	TL-S4-08PF	63	31.3	38	41	21	G1 NPT1

* Note: TL-S4-06PF, Faster interchange
TL-S4-06PF (E), Parker interchange

(PLUG)

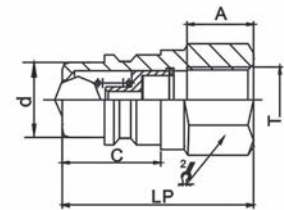

COUPLING FITTING

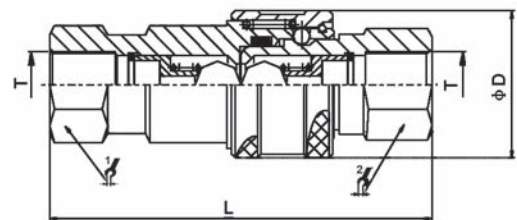

BODY SIZE	PART NO.	L	φD	¹ / ₄	² / ₄	T
6.3	TL-S4-02	72.2	27.6	19	19	G1/4 NPT1/4
10	TL-S4-03	82.6	34	24	24	G3/8 NPT3/8
12.5	TL-S4-04	87.8	38.6	27	27	G1/2 NPT1/2
*	20 TL-S4-06	107.8	48.2	34	34	G3/4 NPT3/4
*	20 TL-S4-06 (E)	102	47.5	35	35	G3/4 NPT3/4
25	TL-S4-08	126.8	56.2	41	41	G1 NPT1

* Note: TL-S4-06, Faster interchange
TL-S4-06 (E), Parker interchange

TL-PK

ISO 5675. Steel. Socket BSPP-NPT. Plug BSPP-NPT

APPLICATIONS

The TL-PK Series brings to the industry a proven design for use on construction equipment, forestry equipment, agricultural machinery, oil tools, steel mill machinery, and other demanding hydraulic applications.



SPECIFICATIONS

BODY SIZE (in)	RATED PRESSURE (PSI)	RATED FLOW (GPM)	TEMPERATURE RANGE (std seals)	STANDARD SEAL MATERIAL
1/4	5000	3		
3/8	4000	6		
1/2	4000	12	-20°C to +120°C	NBR
3/4	3000	28		
1	3000	50		

FEATURES

- Poppet valves available to prevent uncoupled leakage.
- Poppet valves open automatically when coupled, within rated working pressure, to keep the flow expeditely.
- Critical parts are hardened for durability.
- Dependable ball-locking mechanism holds the mating halves together.
- Socket and plug are precision machined from solid bar stock.
- TL-PK series conforms to the standard of ISO 5675.
- Compatible with PARKER 4000 Series and FASTER NV/NS Series.

PERFORMANCE:

TL-PK (1/4", 3/8", 1/2", 3/4", 1")
(Test fluid: Oil-200SUS)

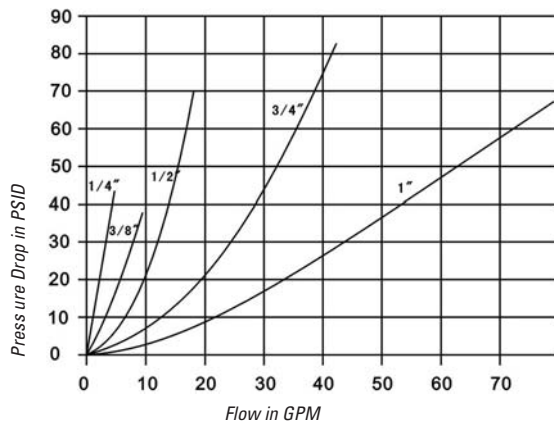

1 GPM= 3.78 L/Min 1PSID= 0.0069 MPa

BODY SIZE	PART NO.	LS	φD	¹ / ₈	A	T
6.3	TL-PK-02SF	55.5	27.6	22.2	12.5	G1/4 NPT1/4
10	TL-PK-03SF	60.5	34	24	13	G3/8 NPT3/8
12.5	TL-PK-04SF	68	38	27	16	G1/2 NPT1/2
*	20 TL-PK-06SF	83	47.5	35	18	G3/4 NPT3/4
*	20 TL-PK-06SF (E)	82.5	48.2	34	19	G3/4 NPT3/4
25	TL-PK-08SF	97.5	56.2	41	21	G1 NPT1

* Note: TL-PK-06SF, Parker interchange
TL-PK-06SF (E), Faster interchange

(SOCKET)

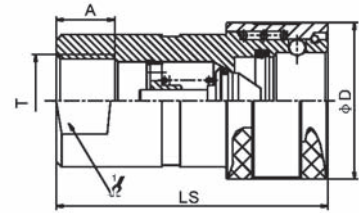

BODY SIZE	PART NO.	LP	d	C	² / ₈	A	T
6.3	TL-PK-02PF	36	14.2	18.5	19	12.5	G1/4 NPT1/4
10	TL-PK-03PF	40	19	22	24	13	G3/8 NPT3/8
12.5	TL-PK-04PF	46	20.5	29	27	16	G1/2 NPT1/2
*	20 TL-PK4-06PF	51	26.9	28.5	33.3	18	G3/4 NPT3/4
*	20 TL-PK-06PF (E)	53.5	28	32	34	19	G3/4 NPT3/4
25	TL-PK-08PF	64	31.3	34	41	21	G1 NPT1

* Note: TL-PK-06PF, Parker interchange
TL-PK-06PF (E), Faster interchange

(PLUG)

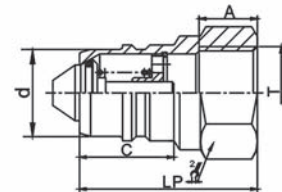

COUPLING FITTING

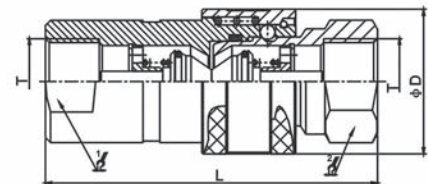

BODY SIZE	PART NO.	L	φD	¹ / ₈	² / ₈	T
6.3	TL-PK-02	74.2	27.6	22.2	19	G1/4 NPT1/4
10	TL-PK-03	80.2	34	24	24	G3/8 NPT3/8
12.5	TL-PK-04	92.3	38.5	27	27	G1/2 NPT1/2
*	20 TL-PK-06	102.2	47.5	35	33.3	G3/4 NPT3/4
*	20 TL-PK-06 (E)	107.8	48.2	34	34	G3/4 NPT3/4
25	TL-PK-08	128.8	56.2	41	41	G1 NPT1

* Note: TL-S4-06, Parker interchange
TL-S4-06 (E), Faster interchange

FLAT FACE. ISO 16028

TL-FF

ISO 16028. Flat face. Steel. Socket BSPP-NPT. Plug BSPP-NPT

APPLICATIONS

TL-FF Series couplings are widely used in the public utility market where hydraulic oil spillage can constitute a serious safety hazard, particularly in overhead bucket hoists that are used for maintenance of high-voltage power transmission lines.

These couplings are also used for quick change of hydraulic tools in construction, railway maintenance and mining industries.

The ease of cleaning makes them ideal for use in these types of hostile environments.



SPECIFICATIONS

BODY SIZE (in)	RATED PRESSURE (PSI)	RATED FLOW (GPM)	TEMPERATURE RANGE (std seals)	SPILLAGE (ML) (max. per disconnect)	STANDARD SEAL MATERIAL
1/4 (02)	5000	3	-20°C to +120°C	0.006	NBR
3/8 (03)	4350	6		0.012	
1/2 (04)	4350	12		0.02	
5/8 (06)	3625	20		0.026	
3/4 (08)	3625	28		0.032	
1 (10)	3000	50		0.035	
1-1/2 (12)	3000	80		0.05	
2 (16)	3000	100		0.1	

FEATURES

- New valve design, it can resist damage from high flow and the pressure of impulse thus providing advanced performance.
- Sleeve locking mechanism is engaged by rotating sleeve after connection. It prevents accidental disconnection when, the coupling is dragged along the ground.
- Sleeve mechanism is designed to help prevent dirt from entering the internal mechanism and thus causing faulty operation when connecting or disconnecting. The sleeve covers the retaining ring and also incorporates a dust seal in the spring area.
- Steel construction, zinc plated with yellow chrome finish. Hardened nipples and sleeves and solid barstock construction for maximum resistance to damage from hydraulic and mechanical shock.
- This Anti-Blowout Nitrile/PTFE bonded seal is designed to prevent blow-out or damage during severe service conditions.
- Durable ball-locking mechanism assures reliable connections, every time. A large number of locking balls distributes the work load evenly while providing alignment and swiveling action to reduce hose torque and prolong hose life. CAUTION: These products are not to be used as swivels. Rotation under pressure will result in excessive and premature wear.
- TL-FF Series couplings employ flush valving when connecting or disconnecting. This means that the valves are mated together so that only small amounts of fluid can be lost during disconnection or air inclusion during reconnection.
- New chrome plating treatment provides advanced anti-rust performance.
- TL-FF series conforms to standard of ISO 16028.
- Compatible with PARKER FE Series, STUCCHI A8008 Series, AEROQUIP FD89 Series and HANSEN QA2900 Series.

PERFORMANCE:

TL-FF Series (1/4", 3/8", 1/2", 5/8", 3/4", 1")
(Test fluid: Oil-200SUS)

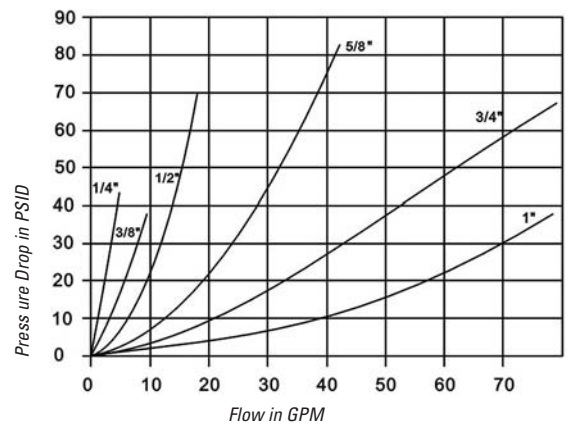

1 GPM = 3.78 L/Min 1PSID = 0.0069 MPa

BODY SIZE	PART NO.	LS	ΦD	$1/2$	A	T	
6.3	TL-FF-02SF	58.2	28	S20	14	G1/4	NPT1/4
10	TL-FF-03SF	68.2	32	S24	14	G3/8	NPT3/8
10	TL-FF-03SF	72.2	32	S27	18	G1/2	NPT1/2
12.5	TL-FF-04SF	75	38	S32	18	G1/2	NPT1/2
12.5	TL-FF-04SF	79	38	S36	22	G3/4	NPT3/4
16	TL-FF-06SF	80	42	S36	22	G3/4	NPT3/4
19	TL-FF-08SF	99.8	48	S41	22	G3/4	NPT3/4
19	TL-FF-08SF	99.8	48	S41	23.5	G1	NPT1
25	TL-FF-10SF	111.5	56	S55	24	G1-1/4	NPT1-1/4
-	TL-FF-12SF	150	79.5	S65	30	G1-1/2	NPT1-1/2
-	TL-FF-16SF	167	98.5	S85	31	G2	NPT2

(SOCKET)

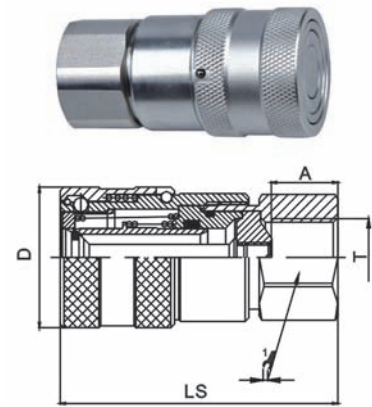

BODY SIZE	PART NO.	LP	d	C	$2/2$	A	T	
6.3	TL-FF-02PF	49.2	16.1	15.2	S20	14	G1/4	NPT1/4
10	TL-FF-03PF	55.8	19.7	19.5	S24	14	G3/8	NPT3/8
10	TL-FF-03PF	59.8	19.7	19.5	S27	18	G1/2	NPT1/2
12.5	TL-FF-04PF	72	24.5	21.6	S32	18	G1/2	NPT1/2
12.5	TL-FF-04PF	76	24.5	21.6	S36	22	G3/4	NPT3/4
16	TL-FF-06PF	75.5	27	21.6	S36	22	G3/4	NPT3/4
19	TL-FF-08PF	93.8	30	29	S41	22	G3/4	NPT3/4
19	TL-FF-08PF	93.8	30	29	S41	23.5	G1	NPT1
25	TL-FF-10PF	90	36	34	S55	24	G1-1/4	NPT1-1/4
-	TL-FF-12PF	112	57	38	S65	30	G1-1/2	NPT1-1/2
-	TL-FF-16PF	123.9	73	40.5	S85	31	G2	NPT2

(PLUG)

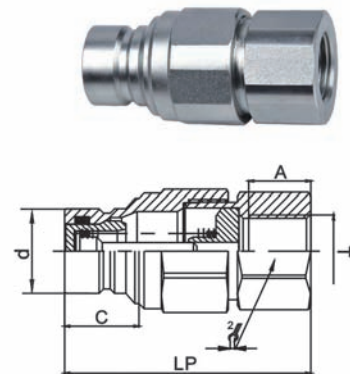

COUPLING FITTING

BODY SIZE	PART NO.	L	D	$1/2$	$2/2$	T	
6.3	TL-FF-02	96.2	28	S20	S20	G1/4	NPT1/4
10	TL-FF-03	108.4	32	S24	S24	G3/8	NPT3/8
10	TL-FF-03	116.4	32	S27	S27	G1/2	NPT1/2
12.5	TL-FF-04	129.3	38	S32	S32	G1/2	NPT1/2
12.5	TL-FF-04	137.3	38	S36	S36	G3/4	NPT3/4
16	TL-FF-06	138	42	S36	S36	G3/4	NPT3/4
19	TL-FF-08	172.1	48	S41	S41	G3/4	NPT3/4
19	TL-FF-08	172.1	48	S41	S41	G1	NPT1
25	TL-FF-10	178	56	S55	S55	G1-1/4	NPT1-1/4
-	TL-FF-12	233.4	79.5	S65	S65	G1-1/2	NPT1-1/2
-	TL-FF-16	251.7	98.5	S85	S75	G2	NPT2

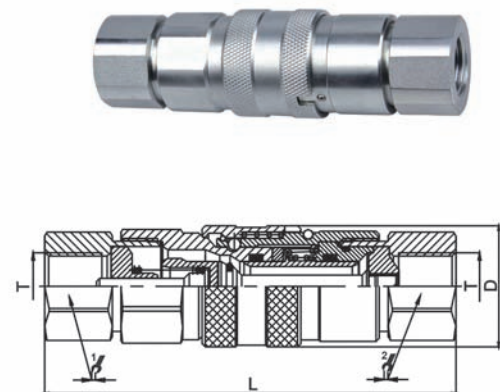

TL-VEP

Flat Face. Threaded union lock. Steel. Socket BSPP- NPT. Plug BSPP-NPT

APPLICATIONS

Portable construction equipments.
Hydraulic tools.
Vehicles.



SPECIFICATIONS

BODY SIZE (in)	RATED PRESSURE (PSI)	RATED FLOW (GPM)	TEMPERATURE RANGE (std seals)	STANDARD SEAL MATERIAL
1/2 (04)	7000	12		
5/8 (06)	7000	28		
3/4 (08)	7000	50	-20°C to +120°C	NBR
1 (10)	6000	88		
1-1/2 (12)	5000	152		

FEATURES

- New valve design, it can resistance damage from high flow and the pressure of impulse that providing advanced performance.
- Special nipple design for connecting under pressure, allows connection and disconnection with high residual pressures.
- The TL-VEP series employs a threaded sleeve locking mechanism, mates with matching male threads on the coupler. The two halves must be manually threaded together for connection.
- New chrome plating treatment provides advanced anti-rust performance
- TL-VEP series couplings employ flush valving when connecting or disconnecting. This means that the valves are mated together so that only small amounts of fluid can be lost during disconnecting or air inclusion during reconnection.
- This Anti-Blowout BFT bonded seal is designed to prevent blow-out or damage during severe service conditions.
- Machined form solid steel barstock for durability. Compatible with STUCCHI VEP Series.

PERFORMANCE:

TL-VEP Series (1/2", 5/8", 3/4", 1", 1-1/4")
(Test fluid: Oil-200SUS)

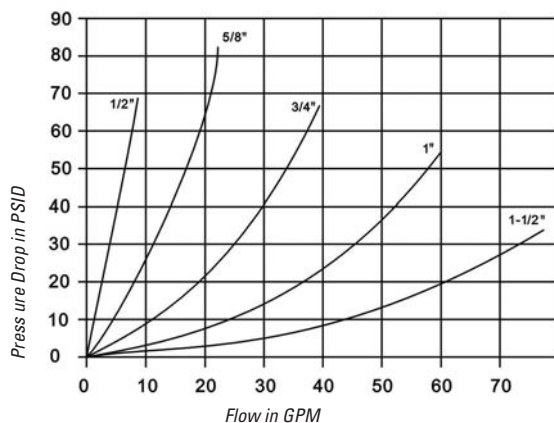

1 GPM= 3.78 L/Min 1PSID= 0.0069 MPa

(SOCKET)

BODY SIZE	PART NO.	LS	ΦD	¹ ↯	³ ↯	A	T	
13	TL-VEP-04SF	103.5	49	S36	S46	16.5	G1/2	NPT1/2
16	TL-VEP-06SF	114	53.7	S41	S50	20	G3/4	NPT3/4
19	TL-VEP-08SF	133.5	58.8	S46	S55	21	G1	NPT1
25	TL-VEP-10SF	145.2	68.7	S55	S65	21	G1-1/4	NPT1-1/4
31.5	TL-VEP-12SF	187.5	92	S65	S85	21	G1-1/2	NPT1-1/2

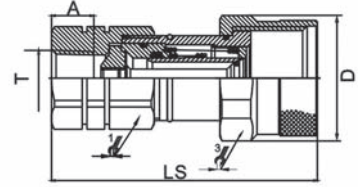

(PLUG)

BODY SIZE	PART NO.	LS	C	d	E	² ↯	A	T	
13	TL-VEP-04PF	95	18.8	24.54	M40*3	S36	16.5	G1/2	NPT1/2
16	TL-VEP-06PF	98.8	19.5	27.04	M45*3	S36	20	G3/4	NPT3/4
19	TL-VEP-08PF	113.9	24	29.95	M50*3	S46	21	G1	NPT1
25	TL-VEP-10PF	123.5	24.8	36.05	M58*3	S55	21	G1-1/4	NPT1-1/4
31.5	TL-VEP-12PF	150	31.5	57	Tr80*4	S65	21	G1-1/2	NPT1-1/2

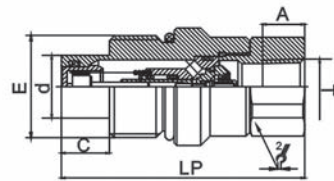

COUPLING FITTING

BODY SIZE	PART NO.	L	ΦD	¹ ↯	² ↯	³ ↯	T	
13	TL-VEP-04	154.5	49	S36	S46	S36	G1/2	NPT1/2
16	TL-VEP-06	164.3	53.7	S41	S50	S36	G3/4	NPT3/4
19	TL-VEP-08	189.4	58.8	S46	S55	S46	G1	NPT1
25	TL-VEP-10	207.2	68.7	S55	S65	S55	G1-1/4	NPT1-1/4
31.5	TL-VEP-12	263.5	92	S65	S85	S65	G1-1/2	NPT1-1/2

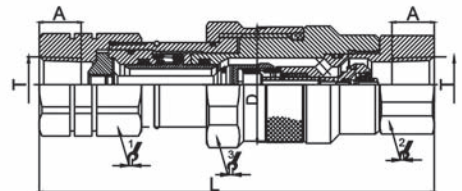

TL-PD

APPLICATIONS

TL-PD series brings to the industry a proven design for use on hydraulic system and hydraulic test ports.



SPECIFICATIONS

BODY SIZE (in)	RATED PRESSURE (PSI)	RATED FLOW (GPM)	TEMPERATURE RANGE (std seals)	STANDARD SEAL MATERIAL
1/4	6000	0.53	-20°C to +120°C	NBR

FEATURES

- New valve design, it cans resistance damage from high flow and the pressure
- Flush-face poppet valves minimize air inclusion and spillage.
- Poppet valves available to prevent uncoupled leakage.
- Poppet valves open automatically when coupled, within rated working pressure, to keep the flow expedately.
- Critical parts are hardened for durability.
- Dependable ball-locking mechanism holds the mating halves together.
- Socket and plug are precision machined from solid bar stock.
- Compatible with FASTER DF Series, PARKER PD Series, AEROQUIP FD 90 Series.

PERFORMANCE:

TL-PD Series
(Test fluid: Oil-200SUS)

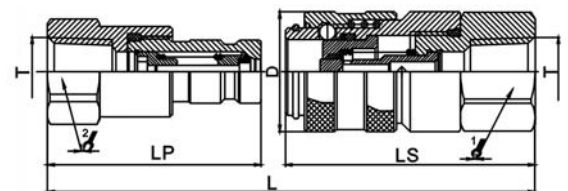
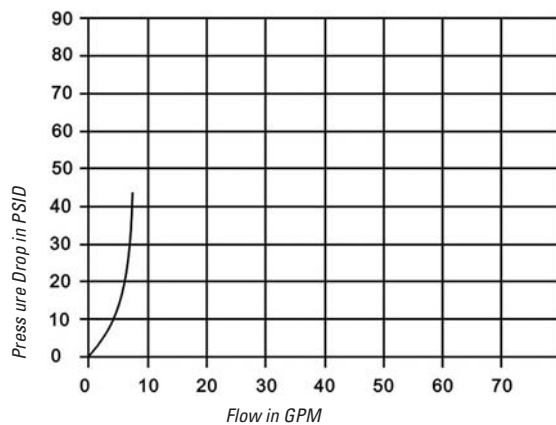

1 GPM= 3.78 L/Min 1PSID= 0.0069 MPa

THREAD LOCK

TL-KZE-B

Threaded union lock. Steel. Socket NPT-Plug NPT

APPLICATIONS

TL-KZE-B Series couplings with their threaded union locking system and precision ball-type check valves, are designed for extreme high pressure applications such as portable hydraulic jacks.

SPECIFICATIONS

BODY SIZE (in)	RATED PRESSURE (PSI)	RATED FLOW (GPM)	TEMPERATURE RANGE (std seals)	STANDARD SEAL MATERIAL
1/4	10000	3	-20°C to +120°C	NBR
3/8		6		



FEATURES

- Machined from solid steel barstock for durability.
- The TL-KZE-B Series employs a threaded sleeve locking mechanism, mates with matching male threads on the nipple. The two halves must be manually threaded together for connection.
- Hard, chrome alloy balls are used for valving. They are spring loaded for positive seating of the valve.
- The valve provides a metal-to-metal seal between the ball and coined seat.
- The interface seal is polyurethane which resists high pressure extrusion.
- Compatible with PARKER 3000 Series and FASTER PVVM Series.

PERFORMANCE:

TL-KZE-B Series (1/4", 3/8")
(Test fluid: Oil-200SUS)

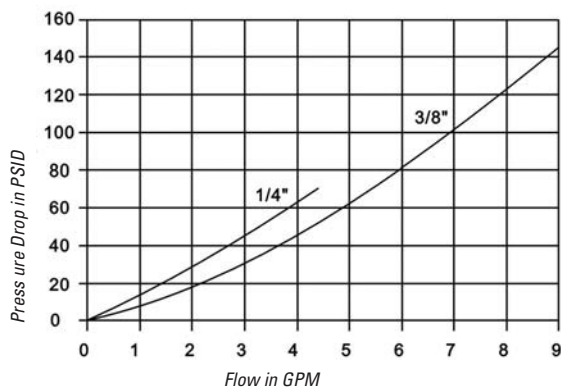

1 GPM= 3.78 L/Min 1PSID= 0.0069 MPa

PART NO.	LS	ΦD	$\frac{1}{2}$	A	T
TL-KZE-B-02SM	60.8	28.5	22	13.5	NPT1/4
TL-KZE-B-03SM	73.5	35	25	14.4	NPT3/8

(SOCKET)

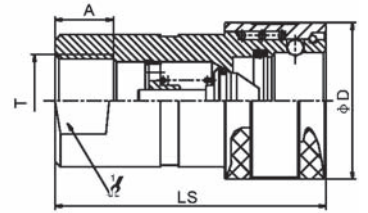

PART NO.	LP	C	$\frac{2}{2}$	A	T
TL-KZE-B-02PF	32.5	11.2	19	13	NPT1/4
TL-KZE-B-03PF	35	16	32	13.5	NPT3/8

(PLUG)

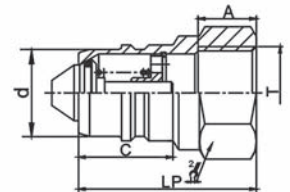

PART NO.	L	ΦD	$\frac{1}{2}$	$\frac{2}{2}$	T
TL-KZE-B-02	74.5	28.5	22	19	NPT1/4
TL-KZE-B-03	83.5	35	25	32	NPT3/8

COUPLING FITTING

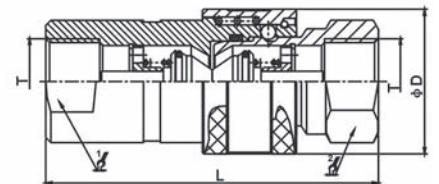

Note: Mark "Ball" after the Part No., if the valve require ball valve.

TL-KZE-BA

Threaded union lock. Steel. Socket NPT-BSPP. Plug BSPP-NPT

APPLICATIONS

Mobile equipment, agriculture machine and universal industrial equipment.



SPECIFICATIONS

BODY SIZE (in)	RATED PRESSURE (PSI)	RATED FLOW (GPM)	TEMPERATURE RANGE (std seals)	STANDARD SEAL MATERIAL
1/4	10000	3		
3/8	10000	6		
1/2	10000	12	-20°C to +120°C	NBR
3/4	8500	28		
1	6000	50		

FEATURES

- New valve design, it can resistance damage from high flow and the pressure of impulse that providing advanced performance.
- Machined from solid steel barstock for durability.
- The TL-KZE-BA Series employs a threaded sleeve locking mechanism, mates with matching male threads on the nipple. The two halves must be manually threaded together for connection.
- New chrome plating treatment provides advanced anti-rust performance.
- Compatible with GROMELLE 6000 Series and HOLMBURY TGW Series.

PERFORMANCE:

TL-KZE-B2 Series (1/4", 3/8", 1/2", 3/4", 1")

(Test fluid: Oil-200SUS)

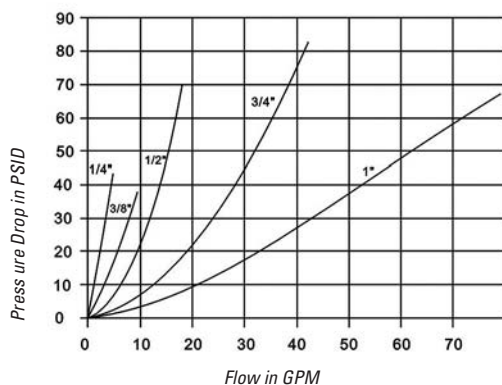

1 GPM= 3.78 L/Min 1PSID= 0.0069 MPa

PART NO.	LS	ΦD	$\frac{1}{4}$	A	T
TL-KZE-BA-02SF	58.9	S32	S19	13	G1/4 NPT1/4
TL-KZE-BA-03SF	66.5	S36	S22	16	G3/8 NPT3/8
TL-KZE-BA-04SF	76.5	S41	S27	18	G1/2 NPT1/2
TL-KZE-BA-06SF	89.5	S50	S35	20.5	G3/4 NPT3/4
TL-KZE-BA-08SF	105.5	S65	S41	20.5	G1 NPT1

(SOCKET)

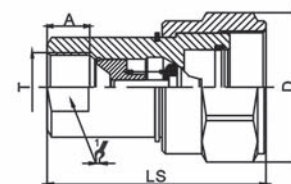

PART NO.	LP	C	$\frac{1}{4}$	A	T
TL-KZE-BA-02PF	36	12.5	S19	13	G1/4 NPT1/4
TL-KZE-BA-03PF	40.5	16	S22	16	G3/8 NPT3/8
TL-KZE-BA-04PF	49	17	S27	18	G1/2 NPT1/2
TL-KZE-BA-06PF	56	19	S35	20.5	G3/4 NPT3/4
TL-KZE-BA-08PF	66	22	S41	20.5	G1 NPT1

(PLUG)

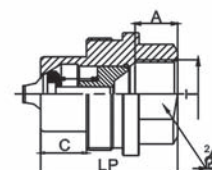

PART NO.	L	ΦD	$\frac{1}{4}$	$\frac{2}{4}$	T
TL-KZE-BA-02	72.3	S32	S19	S19	G1/4 NPT1/4
TL-KZE-BA-03	81.5	S36	S22	S22	G3/8 NPT3/8
TL-KZE-BA-04	98.3	S41	S27	S27	G1/2 NPT1/2
TL-KZE-BA-06	112.4	S50	S35	S35	G3/4 NPT3/4
TL-KZE-BA-08	132.9	S65	S41	S41	G1 NPT1

COUPLING FITTING

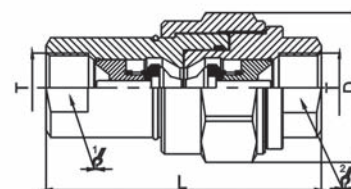

TL-KZE-BD

Threaded union lock. Steel. Socket NPT-BSPP. Plug BSPP-NPT

APPLICATIONS

Mobile equipment, agriculture machine and universal industrial equipment.



SPECIFICATIONS

BODY SIZE (in)	RATED PRESSURE (PSI)	RATED FLOW (GPM)	TEMPERATURE RANGE (std seals)	STANDARD SEAL MATERIAL
1/4	10000	2		
3/8	10000	4.5		
1/2	10000	8		
3/4	10000	12	-20°C to +120°C	NBR
1	7500	24		
1 1/4	6500	35		
1 1/2	5000	75		
2	5000	200		

FEATURES

- New valve design, it can resistance damage from high flow and the pressure of impulse that providing advanced performance.
- Machined from solid steel barstock for durability.
- The TL-KZE-BB Series employs a threaded sleeve locking mechanism, mates with matching male threads on the nipple. The two halves must be manually threaded together for connection.
- New chrome plating treatment provides advanced anti-rust performance.
- Compatible with FASTER VVS Series.

PERFORMANCE:

TL-KZE-BD Series (1/4", 3/8", 1/2", 3/4", 1")

(Test fluid: Oil-200SUS)

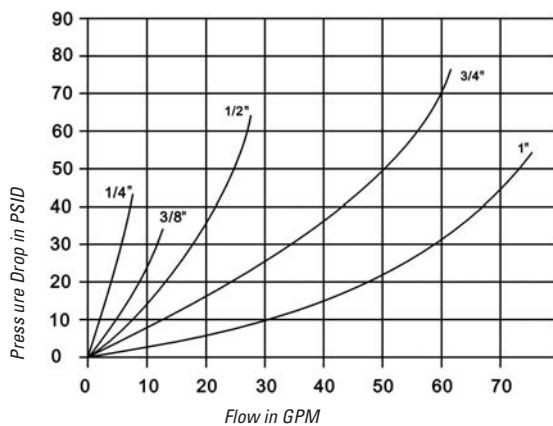

1 GPM= 3.78 L/Min 1PSID= 0.0069 MPa

PART NO.	LS	ΦD	¹ ⌀	³ ⌀	A	T	
TL-KZE-BD-02SF	68	30	23	27	16	G1/4	NPT1/4
TL-KZE-BD-03SF	75.6	39.7	30	36	14.5	G3/8	NPT3/8
TL-KZE-BD-04SF	86.4	45	34	41	19	G1/2	NPT1/2
TL-KZE-BD-06SF	105.5	53.8	41	50	23	G3/4	NPT3/4
TL-KZE-BD-08SF	123	58.8	50	55	23	G1	NPT1
TL-KZE-BD-10SF	152.5	78.5	65	75	26	G1-1/4	NPT1-1/4
TL-KZE-BD-12SF	172	98	75	90	27	G1-1/2	NPT1-1/2
TL-KZE-BD-16SF	206.5	129	100	125	27	G2	NPT2

(SOCKET)

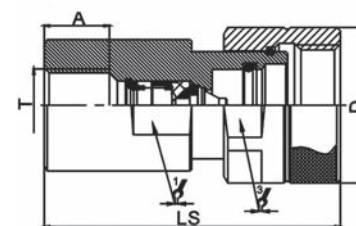

PART NO.	LP	² ⌀	A	T	
TL-KZE-BD-02PF	43	25	13	G1/4	NPT1/4
TL-KZE-BD-03PF	48	32	16	G3/8	NPT3/8
TL-KZE-BD-04PF	53	34	18	G1/2	NPT1/2
TL-KZE-BD-06PF	63	46	21	G3/4	NPT3/4
TL-KZE-BD-08PF	72	50	23	G1	NPT1
TL-KZE-BD-10PF	86	65	26	G1-1/4	NPT1-1/4
TL-KZE-BD-12PF	95	80	27	G1-1/2	NPT1-1/2
TL-KZE-BD-16PF	118	110	27	G2	NPT2

(PLUG)

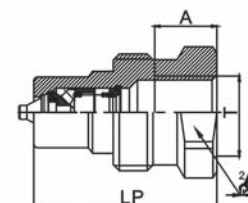

PART NO.	L	ΦD	¹ ⌀	² ⌀	³ ⌀	T	
TL-KZE-BD-02	84.2	30	23	25	27	G1/4	NPT1/4
TL-KZE-BD-03	89.5	39.7	30	32	36	G3/8	NPT3/8
TL-KZE-BD-04	102.2	45	34	34	41	G1/2	NPT1/2
TL-KZE-BD-06	121.2	53.8	41	46	50	G3/4	NPT3/4
TL-KZE-BD-08	138.5	58.8	50	50	55	G1	NPT1
TL-KZE-BD-10	167.5	78.5	65	65	75	G1-1/4	NPT1-1/4
TL-KZE-BD-12	188	98	75	80	90	G1-1/2	NPT1-1/2
TL-KZE-BD-16	227.4	129	100	110	125	G2	NPT2

COUPLING FITTING

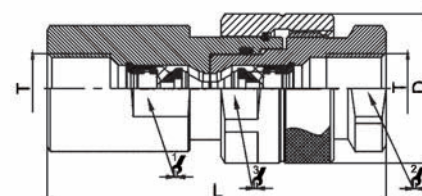

TL-CVV

Threaded union lock. Steel. Socket NPT-BSPP. Plug BSPP-NPT. O-ring

APPLICATIONS

The TL-CVV Series widely used in equipments (excavators) vehicles, hydraulic equipments drilling machines.



SPECIFICATIONS

BODY SIZE (in)	RATED PRESSURE (PSI)	RATED FLOW (GPM)	TEMPERATURE RANGE (std seals)	STANDARD SEAL MATERIAL
1/4	5000	3		
3/8	5000	6		
1/2	5000	12	-20°C to +120°C	NBR
3/4	4500	28		
1	4500	50		

FEATURES

- New valve design, it can resistance damage from high flow and the pressure of impulse that providing advanced performance.
- Machined from solid steel barstock for durability.
- The TL-CVV Series employs a threaded sleeve locking mechanism, mates with matching male threads on the coupler. The two halves must be manually threaded together for connection.
- New chrome plating treatment provides advanced anti-rust performance.
- A threaded valve retainer provides a valve stop that assures positive valve alignment.
- Compatible with FASTER CVV Series STUCCHI VD Series.

PERFORMANCE:

TL-CVV Series (1/4", 3/8", 1/2", 3/4", 1")

(Test fluid: Oil-200SUS)

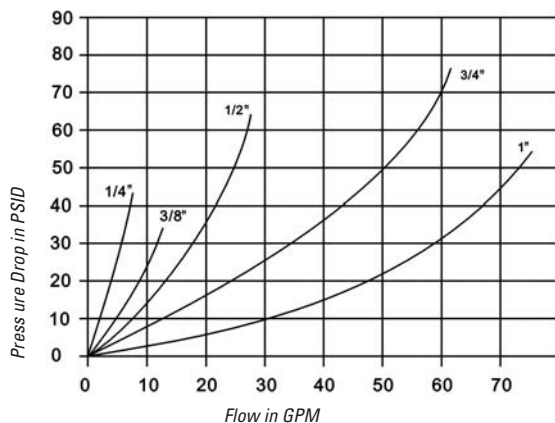

1 GPM= 3.78 L/Min 1PSID= 0.0069 MPa

PART NO.	LS	ΦD	¹ /	³ /	A	T	
TL-CVV-02SF	58.6	34	S19	S30	13	G1/4	NPT1/4
TL-CVV-03SF	60.8	34	S22	S30	13	G3/8	NPT3/8
TL-CVV-04SF	67.7	42	S27	S36	18	G1/2	NPT1/2
TL-CVV-06SF	73.5	48	S36	S41	18	G3/4	NPT3/4
TL-CVV-08SF	94.5	56.5	S41	S51	24.5	G1	NPT1

(SOCKET)

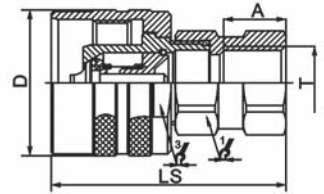

PART NO.	LP	D	² /	A	T	
TL-CVV-02PF	60	M24*2	S19	13	G1/4	NPT1/4
TL-CVV-03PF	55.3	M28*2	S22	13	G3/8	NPT3/8
TL-CVV-04PF	61.5	M36*2	S27	18	G1/2	NPT1/2
TL-CVV-06PF	83.5	M42*2	S36	18	G3/4	NPT3/4
TL-CVV-08PF	94.5	M48*3	S41	24.5	G1	NPT1

(PLUG)

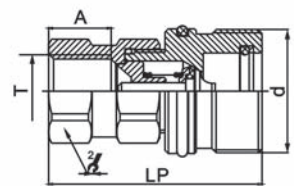

PART NO.	L	ΦD	¹ /	² /	³ /	T	
TL-CVV-02	92.6	34	S19	S19	S30	G1/4	NPT1/4
TL-CVV-03	89.9	34	S22	S22	S30	G3/8	NPT3/8
TL-CVV-04	103	42	S27	S27	S36	G1/2	NPT1/2
TL-CVV-06	125	48	S36	S36	S41	G3/4	NPT3/4
TL-CVV-08	155	56.5	S41	S41	S50	G1	NPT1

COUPLING FITTING

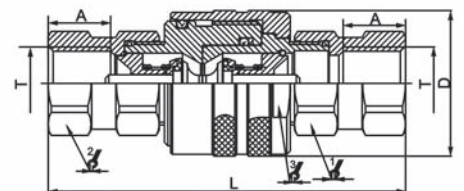

TL-BB

Threaded union wingnut lock. Socket BSPP. Plug BSPP. O-ring

APPLICATIONS

The TL-BB Series is a thread -to-connect. It can be widely used in various application with non-spillage under pressure.

TL-BB Series can be suitable used in connecting equipment of the hydraulic lines like power tongs, swivels and mobile drillings, it also widely used dump tracks, and dump trailer to connect with to wet line hydraulic system. And it also suitable used in submersible pumps, engine test stands, and the equipment require connect under high pressure or high liquid transfer.

SPECIFICATIONS

BODY SIZE (in)	RATED PRESSURE (PSI)	RATED FLOW (GPM)	TEMPERATURE RANGE (std seals)	STANDARD SEAL MATERIAL
3/4	3000	28		
1	3000	50	-20°C to +120°C	NBR
1-1/4	3000	88		



PART NO.	T	ΦD	1	2	L	LS	LP
TL-BB-06	NPT3/4"	106	33.5	29	133.5	66	79.2
TL-BB-08	NPT 1"	110	39.5	36	157	83.5	90
TL-BB-10	NPT 1-1/4"	132	48	45	164	89	94

FEATURES

- TL-BB Heavy-duty wing nut is ruggedly built specifically to withstand the hammer blows commonly used to tighten and loosen this coupler.
- Assembled valve seal can permits full pressure connect and disconnect, without seal washout.
- The flush face valve keeps air inclusion and spillage to a minimum.
- Corrosion resistant brass coupling, makes it compatible with a widely range and provides widely functionality.
- Compatible with PARKER 6100 series, FASTER FB series, AEROQUIP 5100 series, HANSEN 96 series.

PERFORMANCE:

TL-BB Series (3/4", 1", 1-1/4")

(Test fluid: Oil-200SUS)

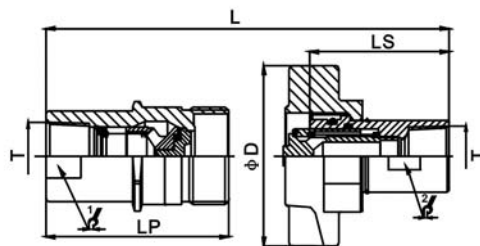
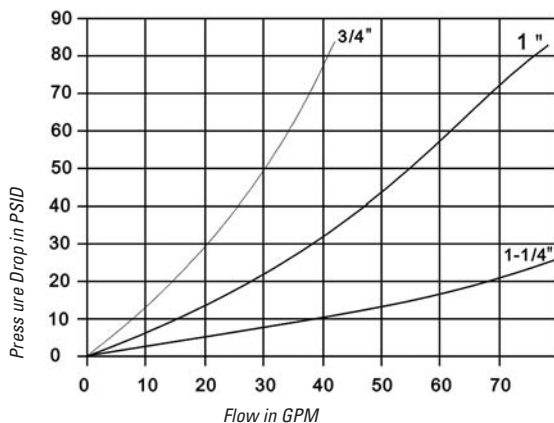

1 GPM= 3.78 L/Min 1PSID= 0.0069 MPa

TL-BC

Threaded union wingnut lock. Socket BSPP. Plug BSPP-NPT. O-ring

APPLICATIONS

The TL-BC Series can widely used on dump tracks, buses, agricultural machinery and mobile construction equipment.

SPECIFICATIONS

BODY SIZE (in)	RATED PRESSURE (PSI)	RATED FLOW (GPM)	TEMPERATURE RANGE (std seals)	STANDARD SEAL MATERIAL
3/4	4000	25	-20°C to +120°C	NBR
1	3000	50		

PART NO.	T	ΦD	¹ / ₄	² / ₄	L	LS	LP
TL-BC-06	G3/4	115.4	46	33	132.5	78	78
TL-BC-08	G1	115.4	55	40	145	83	83

FEATURES

- TL-BC is a thread-to-connect coupling, socket with wing nut can operate by manual with left over pressure.
- Compatible with FASTER CVE series, HOLMBURY VCR series.

PERFORMANCE:

TL-BC Series (3/4", 1")
(Test fluid: Oil-200SUS)

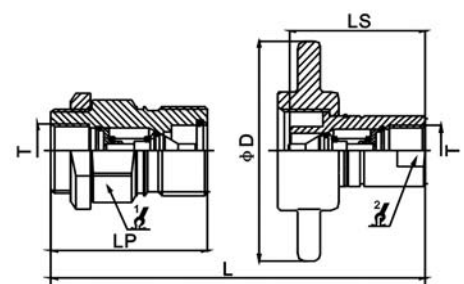
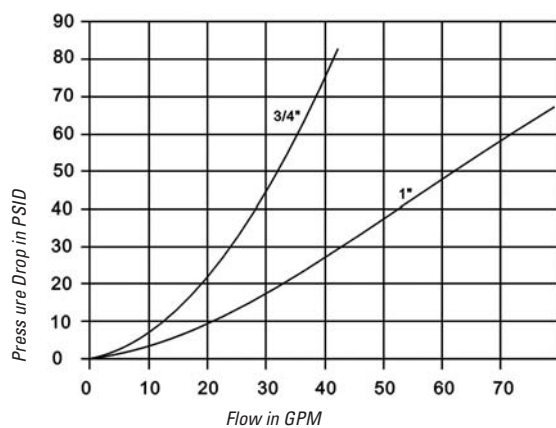

1 GPM= 3.78 L/Min 1PSID= 0.0069 MPa

TL-1141

Threaded union brass nut lock. Socket BSPP. Plug BSPP. O-ring

APPLICATIONS

Portable hydraulic jacks.

SPECIFICATIONS

BODY SIZE (in)	RATED PRESSURE (PSI)	RATED FLOW (GPM)	TEMPERATURE RANGE (std seals)	STANDARD SEAL MATERIAL
1/4	10000	3	-20°C to +120°C	NBR



PART NO.	T	¹ / ₄	² / ₄	³ / ₄	L	LS	LP
TL-1141	NPT 1/4	22	25	22	106.8	50.7	69.9

FEATURES

- 316 Stainless steel body
- Brass locking sleeve
- Thread locking system help prevent coupling from accidentally disconnecting
- Small diameter mating seal helps keep separating forces to a minimum, allowing for easier connect and disconnect at pressure up to 5000 PSI.
- Interchangeability: Parker 1141 Series.

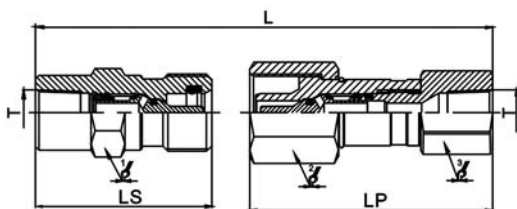

FREE FLOW

TL-LST

APPLICATIONS

The TL-LST Series are non-valved couplings for applications where maximum flow is required. Their smooth, open bore offers the lowest pressure drop of any quick coupling design and is ideal for applications such as high-pressure water and steam washers, carpet cleaners and mold coolant lines and many other non-valved applications.



SPECIFICATIONS

BODY SIZE (in)	BRASS Cplr / Npl	BRASS Cplr /Steel Npl	RATED FLOW (GPM)	TEMPERATURE RANGE (std seals)
1/8	1000	2000	3	-20°C to +120°C
1/4	1000	200	6	
3/8	1000	1500	12	
1/2	1000	1500	12	

FEATURES

- The smooth, open bore with no valving in either half offers minimal pressure drop and allows easy cleaning in applications where the same lines are used for more than one media.
- TL-LST couplers and nipples are machined from solid bar stock providing the quality coupling that is durable.
- TL-LST nipples are available in brass and zinc-plated steel. The ball locking grooves of the steel TL-LST nipples are case hardened for resistance to brinelling where high cycle rates and pressure surges are encountered.
- The TL-LST is an "Interchange" coupling because the dimensionally and functionally can interchange with similar couplings made by other manufacturers.
- Compatible with PARKER ST Series, HANSEN ST Series, FOSTER FST Series.

PERFORMANCE:

TL-LST Series (1/8", 1/4", 3/8", 1/2")
(Test fluid: Oil-200SUS)

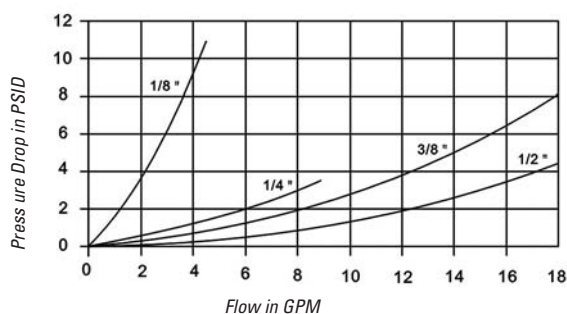

1 GPM= 3.78 L/Min 1PSID= 0.0069 MPa

PART NO.	LS	φD	$1 \frac{1}{4}$	A	T
TL-LST-01SF	27	18	14	10	NPT1/8
TL-LST-02SF	37	24	19	12	NPT1/4
TL-LST-03SF	41.5	29	24	13	NPT3/8
TL-LST-04SF	51	33	29	15	NPT1/2
TL-LST-06SF	53.4	40.9	38	19	NPT3/4
TL-LST-08SF	66	50.5	44.45	22	NPT1

PART NO.	LS	φD	$1 \frac{1}{4}$	A	T
TL-LST-01SM	29	18	14	10	NPT1/8
TL-LST-02SM	39.5	24	19	12	NPT1/4
TL-LST-03SM	43	29	24	13	NPT3/8
TL-LST-04SM	53	33	29	15	NPT1/2
TL-LST-06SM	56.7	40.9	38	19	NPT3/4
TL-LST-08SM	61.1	50.5	44.45	22	NPT1

PART NO.	LP	C	$2 \frac{1}{4}$	A	T
TL-LST-01PF	27	17	14	10	NPT1/8
TL-LST-02PF	37	19.5	17	12	NPT1/4
TL-LST-03PF	41.5	22.5	22	13	NPT3/8
TL-LST-04PF	51	26	27	15	NPT1/2
TL-LST-06PF	52	28.5	30	20	NPT3/4
TL-LST-08PF	60	30.5	38	22	NPT1

PART NO.	LP	C	$2 \frac{1}{4}$	A	T
TL-LST-01PM	29	17	11	10	NPT1/8
TL-LST-02PM	39.5	19.5	14	12	NPT1/4
TL-LST-03PM	43	22.5	17	13	NPT3/8
TL-LST-04PM	53	26	22	15	NPT1/2
TL-LST-06PM	57.2	28.5	27	19	NPT3/4
TL-LST-08PM	62.4	30.5	35	22	NPT1

(SOCKET)

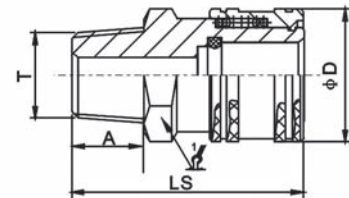
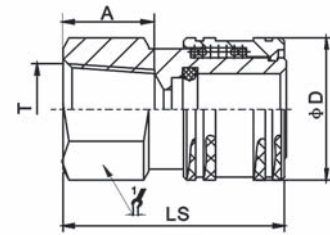

(PLUG)

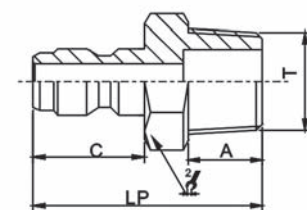
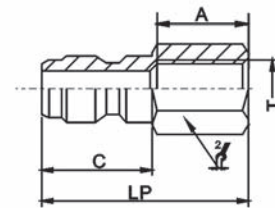
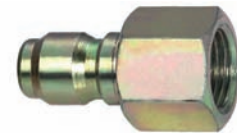

MULTI COUPLING

FLAT SEAL MULTI COUPLING

TL-DL have a compact structure, manual multicouplings that offer a wide range of solutions for any applications requiring connection and disconnection of several hydraulic. Up to 6 line 1/2" can be simultaneously connected and disconnected by a safe, simple and quick movement requiring low effort. The lines can all have the same size or each line can be different from the others according to the application.

MAIN APPLICATIONS:

- Agricultural equipment.
- Mobile construction equipment.
- Vehicles.
- Industrial equipment.

TECHNICAL FEATURES AND OPTIONS:

- Mechanical connection: Internal cams and locking pins.
- Connection system: Rotating the lever.
- Disconnection system: Rotating the lever.
- Construction material and surface treatment:
Body plates in aluminum alloy oxidation.
Cams and pins in high resistance carbon steel with special heat treatment.
- Others components in carbon steel with zinc plating or zinc nickel treatment.



Guidance / locking pins eliminate risk of incorrect connections of the lines

Metal (Aluminum) protection cover for fixed multicoupling

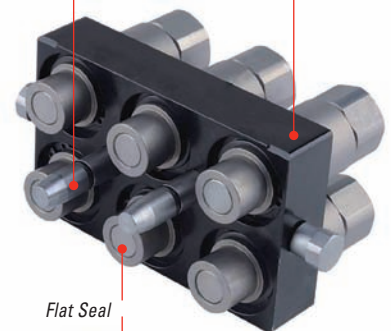

Flat Seal



Safety lock system avoids accidental disconnection

Ergonomic lever for easy connection / disconnection even with high residual pressure in the circuit

ACCESSORIES

TL-S1 CAP

Plastic dust cap and plug for TL-S1

SPECIFICATION	PLUG DUST CAP PART NO.	SOCKET DUST PLUG PART NO.
1/4	TL-S1 PDC-1/4M	TL-S1 PDC-1/4F
3/8	TL-S1 PDC-3/8M	TL-S1 PDC-3/8F
1/2	TL-S1 PDC-1/2M	TL-S1 PDC-1/2F
3/4	TL-S1 PDC-3/4M	TL-S1 PDC-3/4F
1	TL-S1 PDC-1M	TL-S1 PDC-1F
1-1/4	TL-S1 PDC-1-1/4M	TL-S1 PDC-1-1/4F
1-1/2	TL-S1 PDC-1-1/2M	TL-S1 PDC-1-1/2F
2	TL-S1 PDC-2M	TL-S1 PDC-2F

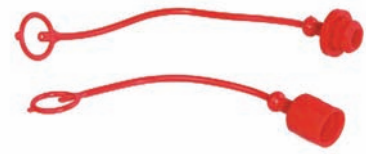

TL-S2 CAP

Plastic dust cap and plug for TL-S2

SPECIFICATION	PLUG DUST CAP PART NO.	SOCKET DUST PLUG PART NO.
1/4	TL-S2 PDC-1/4M	TL-S2 PDC-1/4F
3/8	TL-S2 PDC-3/8M	TL-S2 PDC-3/8F
1/2	TL-S2 PDC-1/2M	TL-S2 PDC-1/2F
3/4	TL-S2 PDC-3/4M	TL-S2 PDC-3/4F
1	TL-S2 PDC-1M	TL-S2 PDC-1F



TL-S4 CAP

Plastic dust cap and plug for TL-S4

SPECIFICATION	PLUG DUST CAP PART NO.	SOCKET DUST PLUG PART NO.
1/4	TL-S4 PDC-1/4M	TL-S4 PDC-1/4F
3/8	TL-S4 PDC-3/8M	TL-S4 PDC-3/8F
1/2	TL-S4 PDC-1/2M	TL-S4 PDC-1/2F
3/4	TL-S4 PDC-3/4M	TL-S4 PDC-3/4F
1	TL-S4 PDC-1M	TL-S4 PDC-1F



TL-S5 CAP

Plastic dust cap and plug for TL-S5

SPECIFICATION	PLUG DUST CAP PART NO.	SOCKET DUST PLUG PART NO.
1/2	TL-S5 PDC-1/2M	TL-S5 PDC-1/2F

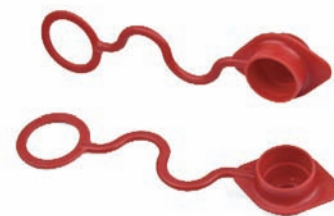

TL-PK CAP

Plastic dust cap and plug for TL-PK

SPECIFICATION	PLUG DUST CAP PART NO.	SOCKET DUST PLUG PART NO.
1/4	TL-PK PDC-1/4M	TL-PK PDC-1/4F
3/8	TL-PK PDC-3/8M	TL-PK PDC-3/8F
1/2	TL-PK PDC-1/2M	TL-PK PDC-1/2F
3/4	TL-PK PDC-3/4M	TL-PK PDC-3/4F
1	TL-PK PDC-1M	TL-PK PDC-1F



TL-FF CAP

Plastic dust cap and plug for TL-FF

SPECIFICATION	PLUG DUST CAP PART NO.	SOCKET DUST PLUG PART NO.
1/4 (02)	TL-FF PDC-1/4M	TL-FF PDC-1/4F
3/8 (03)	TL-FF PDC-3/8M	TL-FF PDC-3/8F
1/2 (04)	TL-FF PDC-1/2M	TL-FF PDC-1/2F
5/8 (06)	TL-FF PDC-5/8M	TL-FF PDC-5/8F
3/4 (08)	TL-FF PDC-3/4M	TL-FF PDC-3/4F
1 (10)	TL-FF PDC-1M	TL-FF PDC-1F



TL-B CAP

Plastic dust cap and plug for TL-B

SPECIFICATION	PLUG DUST CAP PART NO.	SOCKET DUST PLUG PART NO.
1/4	TL-B PDC-1/4M	TL-B PDC-1/4F
3/8	TL-B PDC-3/8M	TL-B PDC-3/8F



TL-B CAP

Metal dust cap and plug for TL-B

SPECIFICATION	PLUG DUST CAP PART NO.	SOCKET DUST PLUG PART NO.
1/4	TL-B MDC-1/4M	TL-B MDC-1/4F
3/8	TL-B MDC-3/8M	TL-B MDC-3/8F



TL-BA CAP

Metal dust cap and plug for TL-BA

SPECIFICATION	PLUG DUST CAP PART NO.	SOCKET DUST PLUG PART NO.
1/4	TL-BA MDC-1/4M	TL-BA MDC-1/4F
3/8	TL-BA MDC-3/8M	TL-BA MDC-3/8F
1/2	TL-BA MDC-1/2M	TL-BA MDC-1/2F
3/4	TL-BA MDC-3/4M	TL-BA MDC-3/4F
1	TL-BA MDC-1M	TL-BA MDC-1F



TL-VEP

Metal dust cap and plug for TL-VEP

SPECIFICATION	PLUG DUST CAP PART NO.	SOCKET DUST PLUG PART NO.
1/2 (04)	TL-VEP MDC-1/2M	TL-VEP MDC-1/2F
5/8 (06)	TL-VEP MDC-5/8M	TL-VEP MDC-5/8F
3/4 (08)	TL-VEP MDC-3/4M	TL-VEP MDC-3/4F
1 (10)	TL-VEP MDC-1M	TL-VEP MDC-1F
1-1/2 (12)	TL-VEP MDC-1-1/2M	TL-VEP MDC-1-1/2F



TL-DUST CAP

General use plastic cap

SPECIFICATION	PART NO.
1/4BSP	1/4BSP(PDC)
1/4NPT	1/4NPT(PDC)
3/8BSP	3/8BSP(PDC)
3/8NPT	3/8NPT(PDC)
1/2BSP	1/2BSP(PDC)
1/2NPT	1/2NPT(PDC)
3/4BSP	3/4BSP(PDC)
3/4NPT	3/4NPT(PDC)
1" BSP	1" BSP(PDC)
1" NPT	1" NPT(PDC)
1-1/4BSP	1-1/4BSP(PDC)
1-1/4NPT	1-1/4NPT(PDC)
1-1/2BSP	1-1/2BSP(PDC)
1-1/2NPT	1-1/2NPT(PDC)
2" BSP	2" BSP(PDC)
2" NPT	2" NPT(PDC)



PNEUMATIC GENERAL PURPOSE

TL-300

ARO 210. Steel. Coupler & Nipple. Male-Male, Female-Female, Hose barb-Hose barb

FEATURES: Valid diameter 5.5mm, ARO210 standard

ADVANTAGES: Large flow valve, single hand operation.

APPLICATION: Pneumatic tools, production and assemble line, machinery equipment.

INTERCHANGEABILITY: Parker 50 Series, Rectus 22KA Series, CEJN 300 Series

WORKING PRESSURE: 1.6Mpa

WORKING TEMPERATURE: -20°C to +120°C

Brass material is optional



PART NO.	LS	ΦD	1/4	A	T	Φd
TL-300-02SM	62.8	23.3	20	13	ZG1/4	7.8
TL-300-03SM	60.8	23.3	20	13	ZG3/8	11.3

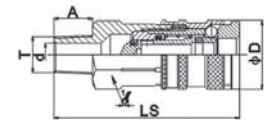

PART NO.	LP	C	2/4	A	T	Φd
TL-300-02PM	41	22	14	13	ZG1/4	5.4
TL-300-03PM	41.5	22	17	13	ZG3/8	5.4

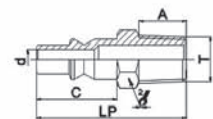

PART NO.	LS	ΦD	1/4	A	T	Φd
TL-300-02SF	59.8	23.3	20	13	G1/4	14
TL-300-03SF	59.8	23.3	22	12	G3/8	14

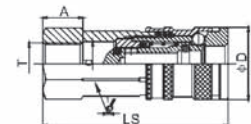

PART NO.	LP	C	2/4	A	T	Φd
TL-300-02PF	38	22	17	13	G1/4	5.4
TL-300-03PF	38	22	19	12	G3/8	5.4

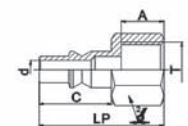

PART NO.	LS	ΦD	1/4	A	ΦT	Φd
TL-300-01SH	69.8	23.3	20	20	7	4
TL-300-02SH	74.8	23.3	20	25	9	5.5
TL-300-03SH	74.8	23.3	20	25	11	7.5

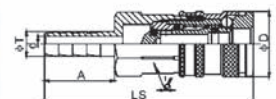

PART NO.	LP	C	ΦCP	A	ΦT	Φd
TL-300-01PH	44.5	22	15	20	7	5.4
TL-300-02PH	49.5	22	15	25	9	5.4
TL-300-03PH	49.5	22	15	25	11	5.4

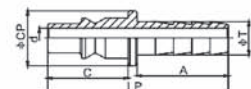

TL-310

ISO 6150B. Steel. Coupler & Nipple. Male-Male, Female-Female, Hose barb-Hose barb

FEATURES: Valid diameter 5.3mm, ISO6150B standard

ADVANTAGES: Large flow valve, single hand operation.

APPLICATION: Pneumatic tools, automotive, machinery equipment.

INTERCHANGEABILITY: Parker 20 Series, Rectus 23KA Series, Hansen 3000, CEJN 300 Series

WORKING PRESSURE: 1.6Mpa

WORKING TEMPERATURE: -20°C to +120°C

Brass material is optional



PART NO.	LS	ΦD	1/2	A	T	Φd
TL-310-02SM	63.2	23.3	20	13	ZG1/4	7.8
TL-310-03SM	61.2	23.3	20	13	ZG3/8	11.3

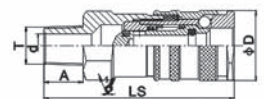

PART NO.	LP	C	2/3	A	T	Φd
TL-310-02PM	43	24	14	13	ZG1/4	5.2
TL-310-03PM	43.5	24	17	13	ZG3/8	5.2

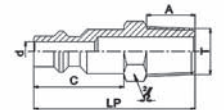

PART NO.	LS	ΦD	1/2	A	T	Φd
TL-310-02SF	60.2	23.3	20	13	G1/4	14
TL-310-03SF	60.2	23.3	22	12	G3/8	14

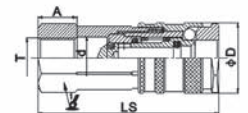

PART NO.	LP	C	2/3	A	T	Φd
TL-310-02PF	40	24	17	13	G1/4	5.2
TL-310-03PF	40	24	19	13	G3/8	5.2

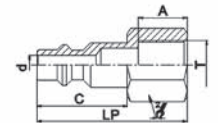

PART NO.	LS	ΦD	1/2	A	ΦT	Φd
TL-310-01SH	70.2	23.3	20	20	7	4
TL-310-02SH	75.2	23.3	20	25	9	5.5
TL-310-03SH	75.2	23.3	20	25	11	7.5

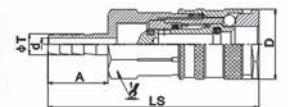

PART NO.	LP	C	ΦCP	A	ΦT	Φd
TL-310-01PH	46.5	24	15	20	7	4
TL-310-02PH	51.5	24	15	25	9	5.5
TL-310-03PH	51.5	24	15	25	11	7.5

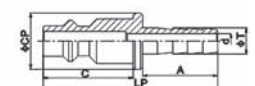

TL-315

JIS. Steel. Coupler & Nipple. Male-Male, Female-Female, Hose barb-Hose barb

FEATURES: Valid diameter 7.5mm, Japanese standard

ADVANTAGES: Large flow valve, single hand operation.

APPLICATION: Pneumatic tools, automotive, machinery equipment.

INTERCHANGEABILITY: Nitto HI-CUPLA Series, CEJN 315 Series, Rectus 13KA Series

WORKING PRESSURE: 1.6Mpa

WORKING TEMPERATURE: -20°C to +120°C

Brass material is optional



PART NO.	LS	ΦD	1/2	A	T	Φd
TL-315-02SM	62.8	23.3	20	13	ZG1/4	7.8
TL-315-03SM	60.8	23.3	20	13	ZG3/8	11.3

PART NO.	LP	C	2/2	A	T	Φd
TL-315-02PM	39.5	20.5	17	13	ZG1/4	7.5
TL-315-03PM	40	20.5	17	13	ZG3/8	7.5

PART NO.	LS	ΦD	1/2	A	T	Φd
TL-315-02SF	57.7	23.3	20	13	G1/4	14
TL-315-03SF	57.7	23.3	22	12	G3/8	14

PART NO.	LP	C	2/2	A	T	Φd
TL-315-02PF	36.5	20.5	17	13	G1/4	7.5
TL-315-03PF	36.5	20.5	19	13	G3/8	7.5

PART NO.	LS	ΦD	1/2	A	ΦT	Φd
TL-315-01SH	67.7	23.3	20	20	7	4
TL-315-02SH	72.7	23.3	20	25	9	5.5
TL-315-03SH	72.7	23.3	20	25	11	7.5

PART NO.	LP	C	ΦCP	A	ΦT	Φd
TL-315-01PH	43	20.5	15	20	7	7.5
TL-315-02PH	48	20.5	15	25	9	7.5
TL-315-03PH	48	20.5	15	25	11	7.5

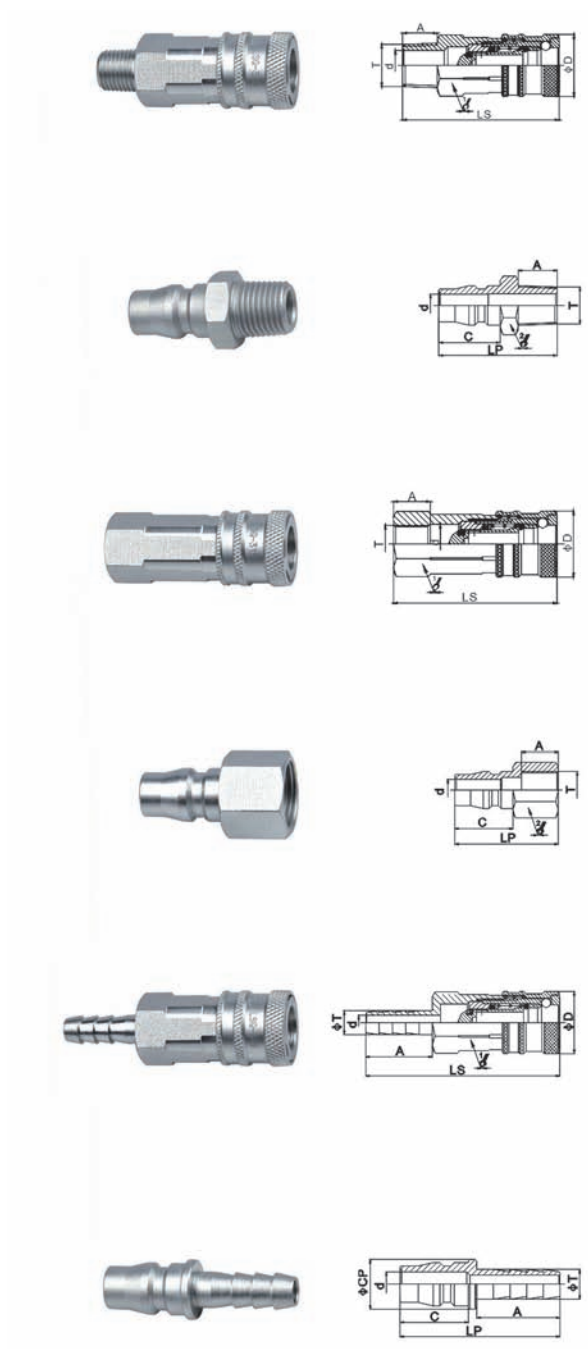

TL-320

ES. Steel. Coupler & Nipple. Male-Male, Female-Female, Hose barb-Hose barb

FEATURES: Valid diameter 7.6mm, European standard

ADVANTAGES: Large flow valve, single hand operation.

APPLICATION: Pneumatic tools, automotive, machinery equipment.

INTERCHANGEABILITY: CEJN 320 Series, Rectus 25KA and 26KA Series

WORKING PRESSURE: 1.6Mpa

WORKING TEMPERATURE: -20°C to +120°C

Brass material is optional



PART NO.	LS	ΦD	$\frac{1}{4}$	A	T	Φd
TL-320-02SM	63.2	23.3	20	13	ZG1/4	7.8
TL-320-03SM	61.2	23.3	20	13	ZG3/8	11.3

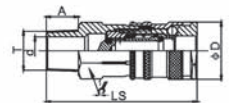

PART NO.	LP	C	$\frac{3}{4}$	A	T	Φd
TL-320-02PM	39.5	20.5	17	13	ZG1/4	7.5
TL-320-03PM	40	20.5	17	13	ZG3/8	7.5

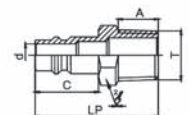

PART NO.	LS	ΦD	$\frac{1}{4}$	A	T	Φd
TL-320-02SF	60.2	23.3	20	13	G1/4	14
TL-320-03SF	60.2	23.3	22	12	G3/8	14

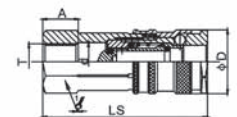

PART NO.	LP	C	$\frac{3}{4}$	A	T	Φd
TL-320-02PF	36.5	20.5	17	13	G1/4	7.5
TL-320-03PF	36.5	20.5	19	13	G3/8	7.5

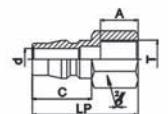

PART NO.	LS	ΦD	$\frac{1}{4}$	A	ΦT	Φd
TL-320-01SH	67.7	23.3	20	20	7	4
TL-320-02SH	72.7	23.3	20	25	9	5.5
TL-320-03SH	72.7	23.3	20	25	11	7.5

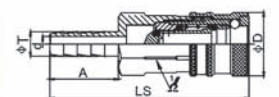

PART NO.	LP	C	ΦCP	A	ΦT	Φd
TL-320-01PH	43	20.5	15	20	7	7.5
TL-320-02PH	48	20.5	15	25	9	7.5
TL-320-03PH	48	20.5	15	25	11	7.5

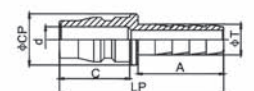

TL-430

ISO 6150B. Steel. Coupler & Nipple. Male-Male, Female-Female, Hose barb-Hose barb

FEATURES: Valid diameter 8.2mm, ISO 6150B standard

ADVANTAGES: Large flow valve, single hand operation.

APPLICATION: Pneumatic tools, automotive, machinery equipment.

INTERCHANGEABILITY: CEJN 430 Series

WORKING PRESSURE: 1.6Mpa

WORKING TEMPERATURE: -20°C to +120°C

Brass material is optional



PART NO.	LS	ΦD	1/2	A	T	Φd
TL-430-03SM	69.3	27.2	24	13	ZG3/8	11.3
TL-430-04SM	69.8	27.2	24	16	ZG1/2	11.3

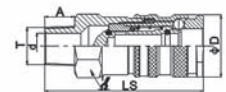

PART NO.	LP	C	2/2	A	T	Φd
TL-430-03PM	46	26.3	17	13	ZG3/8	8.2
TL-430-04PM	51	26.3	22	16	ZG1/2	8.2

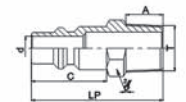

PART NO.	LS	ΦD	1/2	A	T	Φd
TL-430-03SF	67.3	27.2	24	17.1	G3/8	14
TL-430-04SF	68.3	27.2	27	16	G1/2	17.9

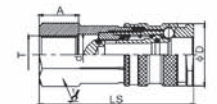

PART NO.	LP	C	2/2	A	T	Φd
TL-430-03PF	42.5	26.3	19	13	G3/8	8.2
TL-430-04PF	47	26.3	27	16	G1/2	8.2

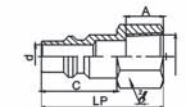

PART NO.	LS	ΦD	1/2	A	ΦT	Φd
TL-430-03SH	81.3	27.2	24	25	11	7.5
TL-430-04SH	86.3	27.2	24	30	15	10

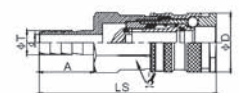

PART NO.	LP	C	ΦCP	A	ΦT	Φd
TL-430-03PH	54	26.3	17	25	11	7.5
TL-430-04PH	59	26.3	17	30	15	10



TL-550

ISO 6150B. Steel. Coupler & Nipple. Male-Male, Female-Female, Hose barb-Hose barb

FEATURES: Valid diameter 11mm, ISO 6150B standard

ADVANTAGES: Large flow valve, single hand operation.

APPLICATION: Pneumatic tools, automotive, machinery equipment.

INTERCHANGEABILITY: CEJN 550 Series

WORKING PRESSURE: 1.6Mpa

WORKING TEMPERATURE: -20°C to +120°C

Brass material is optional



PART NO.	LS	ΦD	1/2	A	T	Φd
TL-550-04SM	79.9	28.1	24	16	ZG1/2	14
TL-550-06SM	81.8	28.1	27	18	ZG3/4	18

PART NO.	LP	C	2/2	A	T	Φd
TL-550-04PM	59.5	35	22	16	ZG1/2	11
TL-550-06PM	63	35	27	18	ZG3/4	18

PART NO.	LS	ΦD	1/2	A	T	Φd
TL-550-04SF	78.3	28.1	27	16	G1/2	17.9
TL-550-06SF	79.8	28.1	32	18	G3/4	17.9

PART NO.	LP	C	2/2	A	T	Φd
TL-550-04PF	55	35	27	16	G1/2	11
TL-550-06PF	57	35	32	18	G3/4	11

PART NO.	LS	ΦD	1/2	A	ΦT	Φd
TL-550-04SH	96.3	28.1	24	30	15	10
TL-550-06SH	96.3	28.1	24	30	20.5	15

PART NO.	LP	C	ΦCP	A	ΦT	Φd
TL-550-04PH	68	35	23	30	15	10
TL-550-06PH	68	35	23	30	20.6	15

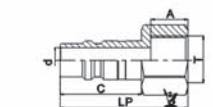
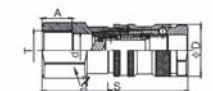
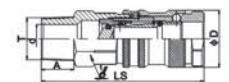

TL-17

Brass. Close type. Coupler & Nipple. Male-Male, Female-Female, Hose barb-Hose barb

FEATURES: Single hand operation, single shut-off.

ADVANTAGES: High flow valve, single hand operation.

APPLICATION: Pneumatic tools, measure and control equipments, and compressed air.

INTERCHANGEABILITY: Rectus 17KA Series

WORKING PRESSURE: 1.0Mpa

WORKING TEMPERATURE: -20°C to +120°C



PART NO.	LS	ΦD	1/2	A	T	Φd
TL-17-02SM	62.5	23.3	19	13	ZG1/4	7
TL-17-03SM	59.5	23.3	19	13	ZG3/8	11
TL-17-04SM	60	23.3	22	14	ZG1/2	14

PART NO.	LP	C	2/2	A	T	Φd
TL-17-02PM	44	25	14	13	ZG1/4	4.6
TL-17-03PM	44.5	25	17	13	ZG3/8	4.6

PART NO.	LS	ΦD	1/2	A	T	Φd
TL-17-02SF	58	23.3	19	10	G1/4	14
TL-17-03SF	57	23.3	19	9	G3/8	14
TL-17-04SF	60	23.3	24	12	G1/2	14

PART NO.	LP	C	2/2	A	T	Φd
TL-17-02PF	41	25	17	13	G1/4	4.6
TL-17-03PF	41	25	19	13	G3/8	4.6

PART NO.	LS	ΦD	1/2	A	ΦT	Φd
TL-17-01SH	72.5	23.3	19	20	7	4
TL-17-02SH	76	23.3	19	25	9	5
TL-17-03SH	76	23.3	19	25	11	7.5

PART NO.	LP	C	ΦCP	A	ΦT	Φd
TL-17-01PH	47.5	25	15	20	7	4.6
TL-17-02PH	52.5	25	15	25	9	4.6
TL-17-03PH	52.5	25	15	25	11	4.6

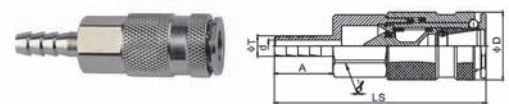
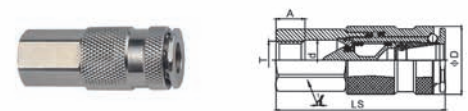
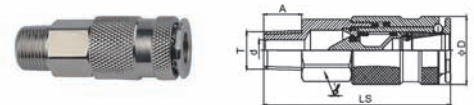

TL-19

Brass. Close type. Coupler & Nipple. Male-Male, Female-Female, Hose barb-Hose barb

FEATURES: Single hand operation, single shut-off.

ADVANTAGES: Single hand operation, high flow valve, plug design optimized through greater insert depth.

APPLICATION: Pneumatic tools, measure and control equipments, and compressed air.

INTERCHANGEABILITY: PCL 60 Series, Rectus 19KA Series

WORKING PRESSURE: 1.0Mpa

WORKING TEMPERATURE: -20°C to +120°C



PART NO.	LS	ΦD	$\frac{1}{4}$	A	T	Φd
TL-19-02SM	64.5	23.3	19	13	ZG1/4	7
TL-19-03SM	63	23.3	19	13	ZG3/8	11
TL-19-04SM	60.5	23.3	22	14	ZG1/2	14

PART NO.	LP	C	$\frac{3}{4}$	A	T	Φd
TL-19-02PM	50.5	31.5	14	13	ZG1/4	4.8
TL-19-03PM	51	31.5	17	13	ZG3/8	4.8

PART NO.	LS	ΦD	$\frac{1}{4}$	A	T	Φd
TL-19-02SF	58.5	23.3	19	10	G1/4	14
TL-19-03SF	57.5	23.3	19	9	G3/8	14
TL-19-04SF	60.5	23.3	24	12	G1/2	14

PART NO.	LP	C	$\frac{3}{4}$	A	T	Φd
TL-19-02PF	47.5	31.5	17	13	G1/4	4.8
TL-19-03PF	47.5	31.5	19	13	G3/8	4.8

PART NO.	LS	ΦD	$\frac{1}{4}$	A	ΦT	Φd
TL-19-01SH	73	23.3	19	20	7	4
TL-19-02SH	76.5	23.3	19	25	9	5
TL-19-03SH	76.5	23.3	19	25	11	7.5

PART NO.	LP	C	ΦCP	A	ΦT	Φd
TL-19-01PH	54	31.5	15	20	7	4.8
TL-19-02PH	59	31.5	15	25	9	4.8
TL-19-03PH	59	31.5	15	25	11	4.8

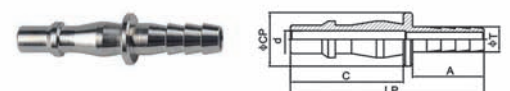
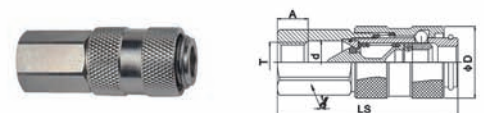
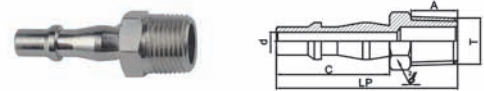
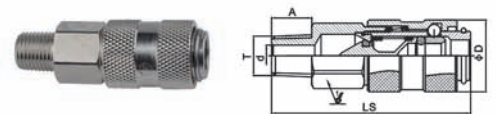

TL-23

Brass. Close type. Coupler & Nipple. Male-Male, Female-Female, Hose barb-Hose barb

FEATURES: Valid diameter 5.3mm, ISO6150B standard.

ADVANTAGES: Large flow valve, single hand operation.

APPLICATION: Pneumatic tools, automotive, machinery equipment.

INTERCHANGEABILITY: Parker 20 Series, Rectus 23KA Series, Hansen 3000 Series, CEJN 310 Series.

WORKING PRESSURE: 1.6Mpa

WORKING TEMPERATURE: -20°C to +120°C



PART NO.	LS	ΦD	1/2	A	T	Φd
TL-23-02SM	61	23.3	19	13	ZG1/4	7
TL-23-03SM	59.5	23.3	19	13	ZG3/8	11
TL-23-04SM	57	23.3	22	14	ZG1/2	14

PART NO.	LP	C	2/2	A	T	Φd
TL-23-02PM	43	24	14	13	ZG1/4	5.2
TL-23-03PM	43.5	24	17	13	ZG3/8	5.2

PART NO.	LS	ΦD	1/2	A	T	Φd
TL-23-02SF	55	23.3	19	10	G1/4	14
TL-23-03SF	54	23.3	19	9	G3/8	14
TL-23-04SF	57	23.3	24	12	G1/2	14

PART NO.	LP	C	2/2	A	T	Φd
TL-23-02PF	40	24	17	13	G1/4	5.2
TL-23-03PF	40	24	19	13	G3/8	5.2

PART NO.	LS	ΦD	1/2	A	ΦT	Φd
TL-23-01SH	69.5	23.3	19	20	7	4
TL-23-02SH	73	23.3	19	25	9	5
TL-23-03SH	73	23.3	19	25	11	7.5

PART NO.	LP	C	ΦCP	A	ΦT	Φd
TL-23-01PH	46.5	24	15	20	7	5.2
TL-23-02PH	51.5	24	15	25	9	5.2
TL-23-03PH	51.5	24	15	25	11	5.2

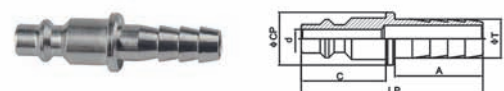
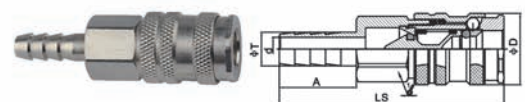
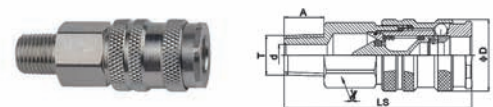

TL-25

Brass. Close type. Coupler & Nipple. Male-Male, Female-Female, Hose barb-Hose barb

FEATURES: Valid diameter 7.6mm, European standard.

ADVANTAGES: Large flow valve, single hand operation.

APPLICATION: Pneumatic tools, automotive, machinery equipment.

INTERCHANGEABILITY: CEJN 320 Series, Rectus 25KA and 26KA Series.

WORKING PRESSURE: 1.6Mpa

WORKING TEMPERATURE: -20°C to +120°C



PART NO.	LS	ΦD	$\frac{1}{4}$	A	T	Φd
TL-25-02SM	61.5	23.3	19	13	ZG1/4	7
TL-25-03SM	60	23.3	19	13	ZG3/8	11
TL-25-04SM	57.5	23.3	22	14	ZG1/2	14

PART NO.	LP	C	$\frac{3}{4}$	A	T	Φd
TL-25-02PM	39.5	20.5	17	13	ZG1/4	7.5
TL-25-03PM	40	20.5	17	13	ZG3/8	7.5

PART NO.	LS	ΦD	$\frac{1}{4}$	A	T	Φd
TL-25-02SF	55.5	23.3	19	10	G1/4	14
TL-25-03SF	54.5	23.3	19	9	G3/8	14
TL-25-04SF	57.5	23.3	24	12	G1/2	14

PART NO.	LP	C	$\frac{3}{4}$	A	T	Φd
TL-25-02PF	36.5	20.5	17	13	G1/4	7.5
TL-25-03PF	36.5	20.5	19	13	G3/8	7.5

PART NO.	LS	ΦD	$\frac{1}{4}$	A	ΦT	Φd
TL-25-01SH	70	23.3	19	20	7	4
TL-25-02SH	73.5	23.3	19	25	9	5
TL-25-03SH	73.5	23.3	19	25	11	7.5

PART NO.	LP	C	ΦCP	A	ΦT	Φd
TL-25-01PH	43	20.5	15	20	7	7.5
TL-25-02PH	48	20.5	15	25	9	7.5
TL-25-03PH	48	20.5	15	25	11	7.5

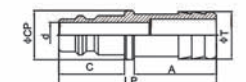
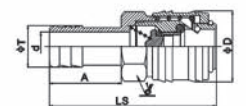
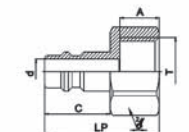
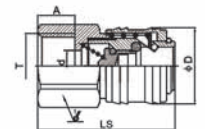
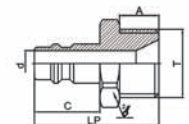
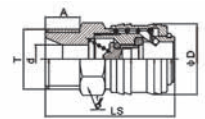

TL-26

Brass. Coupler & Nipple. Male-Male, Female-Female, Hose barb-Hose barb

FEATURES: Valid diameter 7.6mm, European standard.

ADVANTAGES: Single hand operation, steel valve locking system .

APPLICATION: Pneumatic tools, automotive, machinery equipment.

INTERCHANGEABILITY: CEJN 320 Series, Rectus 25KA and 26KA Series.

WORKING PRESSURE: 1.6Mpa

WORKING TEMPERATURE: -20°C to +120°C



PART NO.	LS	ΦD	$\frac{1}{2}$	A	T	Φd
TL-26-02SM	42	24.8	22	9	G1/4	7.8
TL-26-03SM	42	24.8	22	9	G3/8	10
TL-26-04SM	45	24.8	22	12	G1/2	10

PART NO.	LP	C	$\frac{2}{2}$	A	T	Φd
TL-26-02PM	33	20	17	9	G1/4	7.8
TL-26-03PM	33	20	19	9	G3/8	7.8
TL-26-04PM	38	20	24	12	G1/2	7.8

PART NO.	LS	ΦD	$\frac{1}{2}$	A	T	Φd
TL-26-02SF	41.2	24.8	22	10	G1/4	10
TL-26-03SF	41.2	24.8	22	10	G3/8	10
TL-26-04SF	41.2	24.8	24	12	G1/2	10

PART NO.	LP	C	$\frac{2}{2}$	A	T	Φd
TL-26-02PF	33	20	17	9	G1/4	7.8
TL-26-03PF	32	20	19	9	G3/8	7.8
TL-26-04PF	35	20	24	12	G1/2	7.8

PART NO.	LS	ΦD	$\frac{1}{2}$	A	ΦT	Φd
TL-26-01SH	58	24.8	21	25	7.5	4
TL-26-02SH	58	24.8	21	25	9.5	6
TL-26-03SH	58	24.8	21	25	11.5	7.8
TL-26-04SH	58	24.8	21	25	14.5	10

PART NO.	LP	C	ΦCP	A	ΦT	Φd
TL-26-01PH	48	20	12	25	7.5	7.8
TL-26-02PH	48	20	12	25	9.5	7.8
TL-26-03PH	48	20	12	25	11.5	7.8
TL-26-04PH	48	20	12	25	14.5	7.8

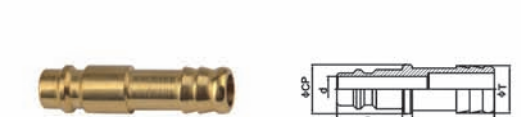

TL-DG

Brass. Coupler & Nipple. Male-Male, Female-Female, Hose barb-Hose barb

FEATURES: Single hand operation, it is widely used in Europe market.

ADVANTAGES: Single hand operation, broad interchange, various of connections.

APPLICATION: Pneumatic tools, laboratories, measure and control equipments, machinery equipment.

INTERCHANGEABILITY: CEJN 320 Series, Rectus 25KA and 26KA Series.

WORKING PRESSURE: 1.0Mpa

WORKING TEMPERATURE: -20°C to +120°C



PART NO.	LS	ΦD	¹ / ₂	A	T
TL-DG-02SM	52.5	25	22	13	1/4
TL-DG-03SM	52.5	25	22	13	3/8
TL-DG-04SM	54.4	25	22	14	1/2

PART NO.	LS	ΦD	¹ / ₂	A	T
TL-DG-02SF	52.5	25	22	13	1/4
TL-DG-03SF	52.5	25	22	13	3/8
TL-DG-04SF	53.5	25	24	14	1/2

PART NO.	LS	ΦD	¹ / ₂	A	T
TL-DG-02SH	64.5	25	22	25	9
TL-DG-03SH	69.5	25	22	30	10.5
TL-DG-04SH	69.5	25	24	30	13

PART NO.	LP	C	² / ₂	A	T
TL-DG-02PM	40	21	14	13	1/4
TL-DG-03PM	40	21	17	13	3/8
TL-DG-04PM	42	21	22	14	1/2

PART NO.	LP	C	² / ₂	A	ΦT
TL-DG-02PF	37	21	17	13	1/4
TL-DG-03PF	38	21	19	13	3/8
TL-DG-04PF	38	21	24	14	1/2

PART NO.	LP	C	ΦCP	A	ΦT
TL-DG-02PH	51	21	14	25	9
TL-DG-03PH	56	21	14	30	10.5
TL-DG-04PH	56	21	14	30	13

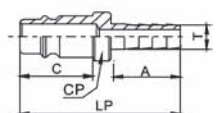
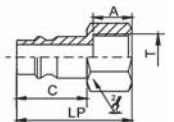
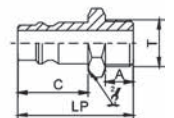
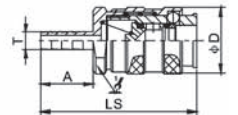
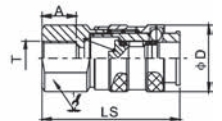
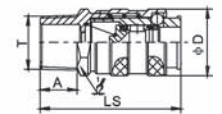

TL-LAM

ISO 6150 B. American type. Brass. Coupler & Nipple. Male-Male, Female-Female, Hose barb-Hose barb

FEATURES: ISO 6150B standard.

ADVANTAGES: Simple structure, light weight, various of connections.

APPLICATION: Pneumatic tools, automotive, compressed air, machinery equipment and compressor.

INTERCHANGEABILITY: Parker 20 Series, Rectus 23KA, Hansen 3000 Series, CEJN 310 Series.

WORKING PRESSURE: 1.0Mpa

WORKING TEMPERATURE: -20°C to +120°C



PART NO.	LS	ΦD	¹ ↗	A	T
TL-LAM-02SM	51	25	19	12	1/4
TL-LAM-03SM	51	25	19	13	3/8
TL-LAM-04SM	53	25	22	14	1/2

PART NO.	LS	ΦD	¹ ↗	A	T
TL-LAM-02SF	49.5	25	19	12	1/4
TL-LAM-03SF	49.5	25	19	12	3/8
TL-LAM-04SF	53.5	25	24	15	1/2

PART NO.	LS	ΦD	¹ ↗	A	T
TL-LAM-02SH	66	25	19	28	9
TL-LAM-03SH	68	25	19	30	10.5
TL-LAM-04SH	68	25	19	30	13

PART NO.	LP	C	² ↗	A	T
TL-LAM-02PM	42	24	14	13	1/4
TL-LAM-03PM	42	24	17	13	3/8
TL-LAM-04PM	44	24	22	14	1/2

PART NO.	LP	C	² ↗	A	ΦT
TL-LAM-02PF	39	24	17	12	1/4
TL-LAM-03PF	40	24	19	13	3/8
TL-LAM-04PF	44	24	24	16	1/2

PART NO.	LP	C	CP	A	ΦT
TL-LAM-02PH	59	24	φ	30	9
TL-LAM-03PH	59	24	φ	30	10.5
TL-LAM-04PH	59	24	φ	30	13

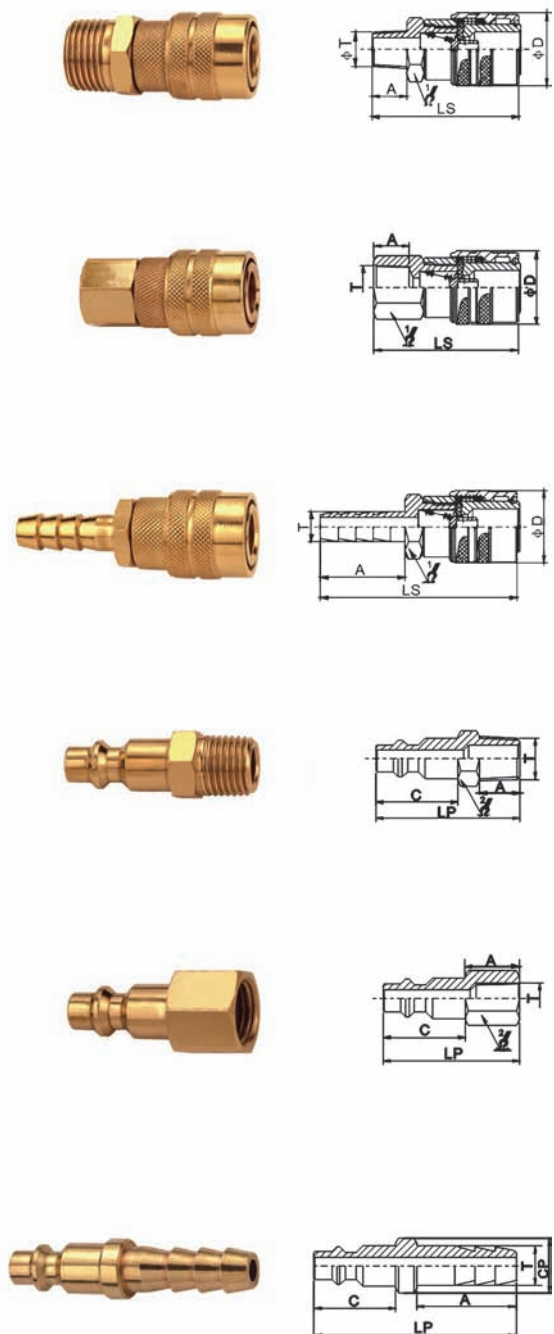

TL-LAO

Single handed and semiautomatic type quick coupling

FEATURES: Single operation, it is widely used in switzerland market.

ADVANTAGES: Simple operation, steel valve locking system.

APPLICATION: Pneumatic tools, producing and assembly lines, machinery equipment.

INTERCHANGEABILITY: Parker 50 Series, Rectus 22KA, CEJN 300 Series.

WORKING PRESSURE: 1.0Mpa

WORKING TEMPERATURE: -20°C to +120°C



PART NO.	LS	ΦD	$\frac{1}{2}$	A	T
TL-LAO-02SM	46	26.8	22	11.5	1/4
TL-LAO-03SM	47	26.8	22	12.5	3/8

PART NO.	LS	ΦD	$\frac{1}{2}$	A	T
TL-LAO-02SF	43.5	26.8	22	11	1/4
TL-LAO-03SF	45.5	26.8	22	11	3/8

PART NO.	LS	ΦD	$\frac{1}{2}$	A	T
TL-LAO-02SH	57.5	26.8	22	25	7
TL-LAO-03SH	57.5	26.8	22	25	9

PART NO.	LP	C	$\frac{2}{2}$	A	T
TL-LAO-02PM	40.5	22	14	11.5	1/4
TL-LAO-03PM	40.5	22	17	12.5	3/8

PART NO.	LP	C	$\frac{2}{2}$	A	ΦT
TL-LAO-02PF	35	22	17	9	1/4
TL-LAO-03PF	36	22	19	11	3/8

PART NO.	LP	C	HP	A	ΦT
TL-LAO-02PH	48.5	22	12	25	7
TL-LAO-03PH	48.5	22	12	25	9

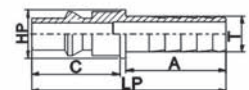
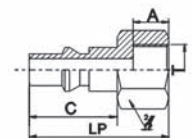
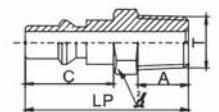
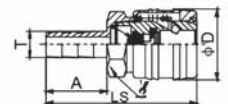
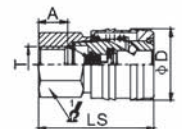
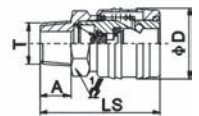



Bearings | **Hydraulics** | Power Transmission

www.translinkpt.com